



ACCESSIBLE LIVING | ASSISTED CARE SHOWERING | INDEPENDENT LIVING CARE

**impey**

[WWW.IMPEYSHOWERS.COM](http://WWW.IMPEYSHOWERS.COM)

# Why specify Impey?

Apart from our pride in being a UK manufacturer here are some reasons why Impey are the number one choice for specialist wetroom healthcare solutions.

With over 25 years' experience, we provide a 'fit for purpose' healthcare solution	<b>Over 500,000 successful installations in the UK</b>
--	--

<b>On-site design surveys and CAD drawings available</b>	Impey provide bespoke survey design requirements to create ideal solutions
--	--

<b>Innovations that make life easier</b>	Innovations can be found everywhere across the Impey range; original ideas that redefine what's possible, adding value and bringing real installer and customer benefits
--	--

Full technical support and training for all installations	<b>Unrivalled product support</b>
---	-----------------------------------

Every member of the sales team is fully qualified to advise on all aspects of our products and installation	<b>Unbeatable service</b>
---	---------------------------

<b>The home of the UK's leading wetroom floor former</b>	Level-Dec EasyFit™ Revolutionary design and unique to Impey
--	---

<b>Committed to our customers</b>	At every opportunity, we advance our systems and processes to improve the customer journey, every step of the way
-----------------------------------	---

We have a dedicated Technical team, offering you instant access to our unmatched specialist knowledge	<b>Comprehensive, risk-free healthcare solutions</b>
---	--

All Impey products conform to ISO 14001 reinforcing our commitment to the environment	<b>Environmental responsibility</b>
---	-------------------------------------

<b>Cost saving installation</b>	Most of our products can be easily fitted by a single installer. Our carefully considered product design ensures minimal installation time
---------------------------------	--

<b>Failsafe quality and reliability</b>	We use only the best materials and rigorous construction methods to ensure the greatest quality and reliability
---	---

## Wetroom and level-access showering for the Care market.

Impey was founded on providing specialist wetroom showering solutions for people with mobility difficulties, pioneering many of the product innovations that now lead the market. Our range of products include walk-in wetroom shower floors for vinyl floor coverings, low access shower trays, shower doors, support rails, shower seats and accessories.

We design innovative, high quality products for the health and care sectors. We work closely with contractors, installers, local authorities and healthcare professionals to provide high quality wetroom solutions for all types of bathroom adaptation, improving the lives of thousands of people every year.

All products are created by our highly skilled team of designers. All backed up by industry standard testing and our in-house technical, surveying and installation support teams.



## Contents

Why specify Impey?	2
UK Manufacturing	4
Shower Planning Guide	8
Wetroom Floor Formers	10
Shower Trays	18
Drainage	38
Shower Doors, Panels, Screens and Curtains	42
Floor and Door Options	50
Shower Seats	64
Grab Rails, Hand Rails and Accessories	72
Boston Comfort & Safety Range	78
Mixer and Electric Showers	80
Showers & Waste Pump Kits	86
Toilets and Bathroom Accessories	90
Impey Guarantee	94

# UK Manufacturing

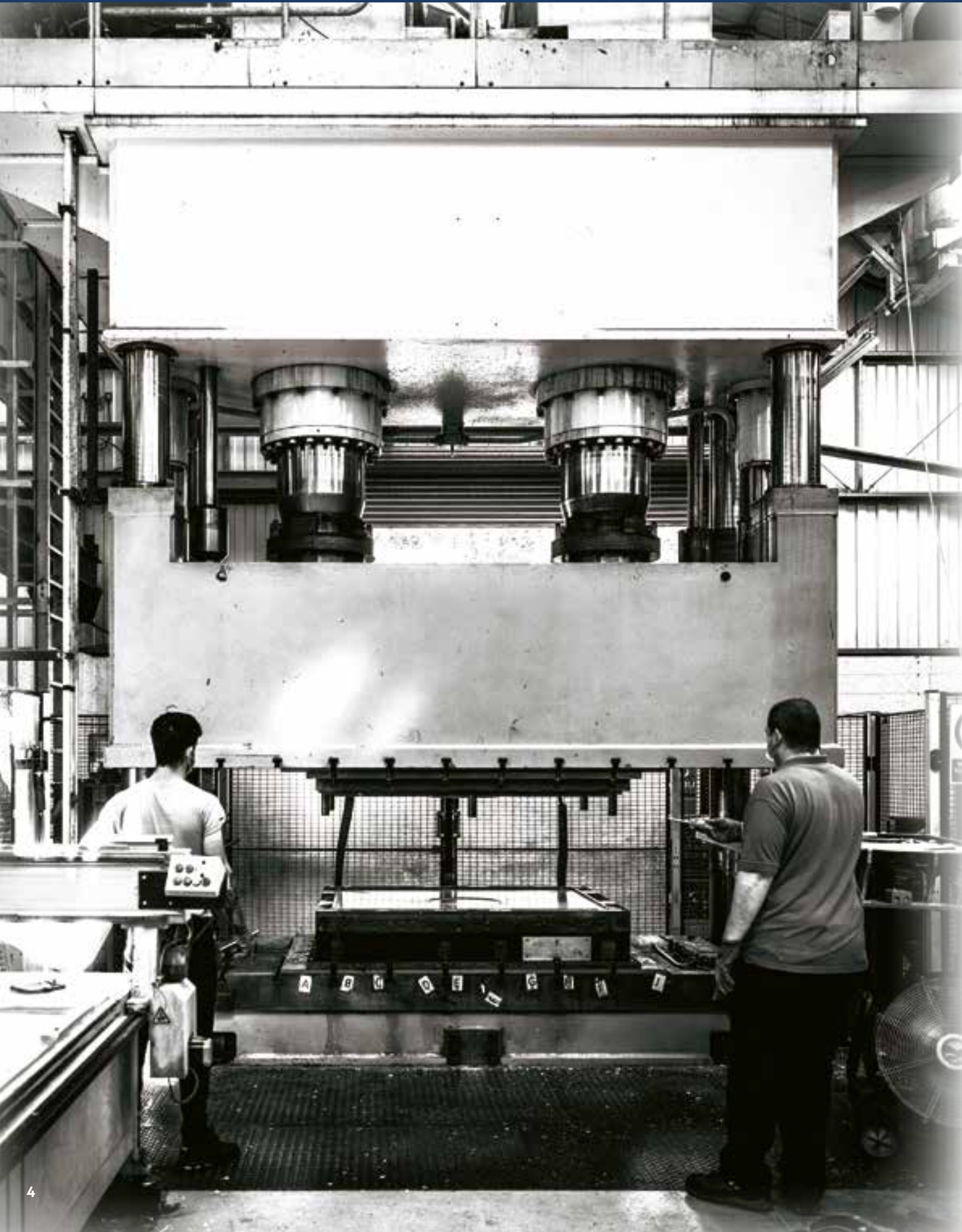



# Made in the UK

Scan the QR code to watch our  
UK Manufacturing video



As a UK-based manufacturer, we are proud to employ a local workforce at our manufacturing site in Bridgnorth, Shropshire, as well as at our head office in Ilton, Somerset.

At our Bridgnorth factory, we have integrated a variety of streamlined, modern manufacturing processes across the Impey product range to ensure all our products are of unparalleled quality and produced as efficiently as possible. Each Impey product is made with the highest levels of care and attention to detail.

We have invested in a wide variety of advanced manufacturing processes to enable us to deliver market-leading solutions, across a wide range of technologies. All supported with our own design, engineering and continuous improvement teams. These drive the use of new materials, in-house tooling, processes and offerings, whilst ensuring compliance through our own testing facility.

Having all supporting departments based in Ilton, we can consistently deliver a high level of customer service with confidence. All of our employees are product trained by our Technical team so they are able to provide the best advice and solutions to all of our customers.

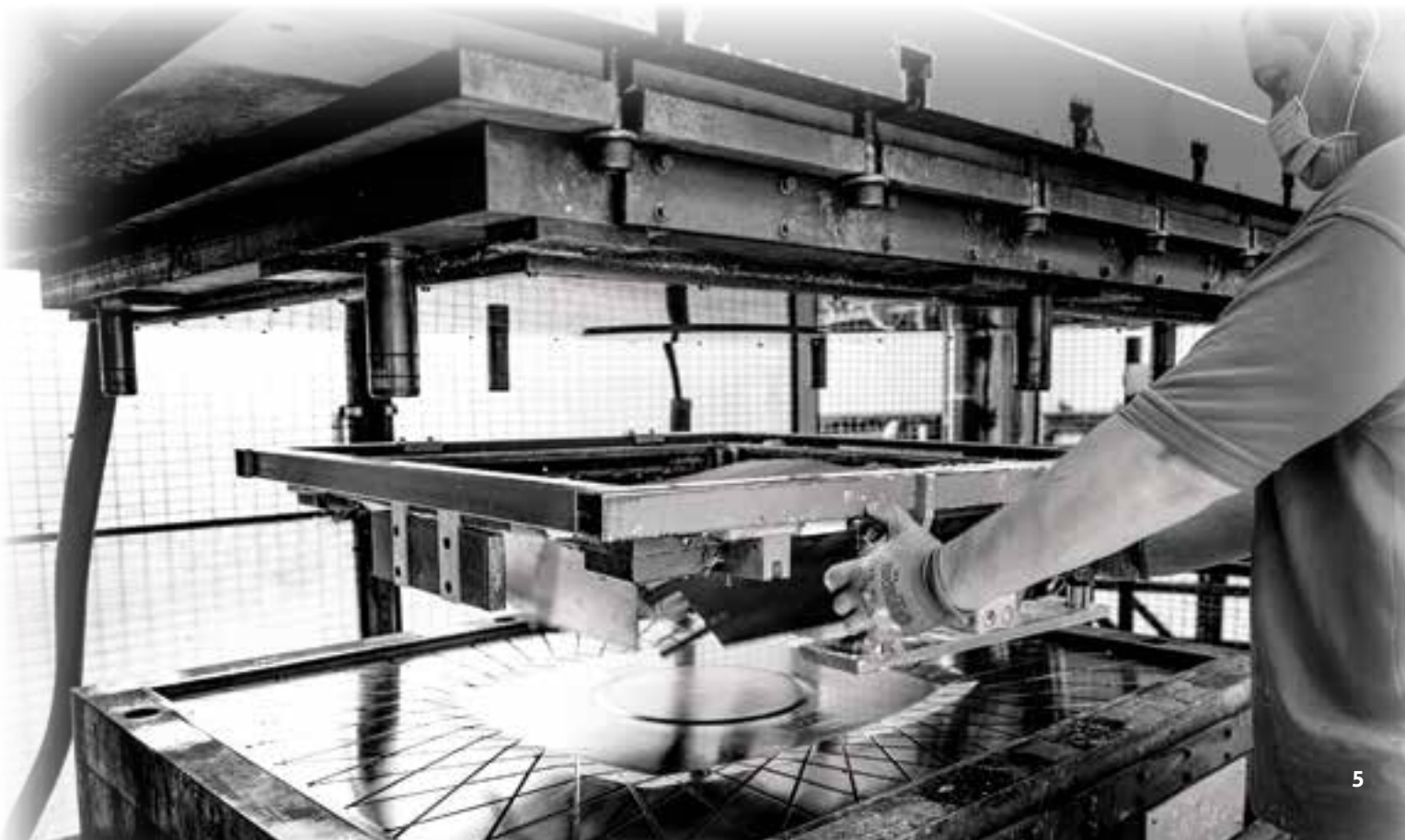

## Manufacturing capabilities in Bridgnorth

With over 25 years of complete manufacturing based within the UK, we have been able to adapt and improve our manufacturing techniques and progress our products by doing so. Some of these processes include:

- Manufacturing Level-Dec EasyFit™ is a semi-automated thermoset compression process. The SMC material is manually fed onto a mold which is heated to approximately 145°C. The mold sits in a hydraulic press which is manually operated to close the tool and apply pressures of up to 800 ton on a floor former. Under both compression and heat the material liquefies and fills the tool cavity before re-solidifying and hardening. The floor former is then lifted off by two team members, in unison, and checked. It then undergoes a post process operation which involves the removal of the centre drainage area by a machine process and is finished by hand
- The manufacture of our Half Height Shower Doors involves sawing, bending and drilling of aluminium extrusions which is then assembled into a frame or support. The frame structure is secured to plastic panels using either adhesives or screws and gaskets. Extensive hand operated poka yoke tooling, used to deliver agile response times on products
- The process of manufacturing GRP Shower Trays uses spray gel, resin and glass chop. A mold is taken and a spray coating of white gel coat is applied and left to cure for half an hour. Next several coats of resin and glass chop is applied and rolled out in the mold. It is then left to cure for several hours
- Thermoform processes to provide Shower Tray options, all backed up with CNC (Computer Numerical Control) trimming capacity to ensure dependability.

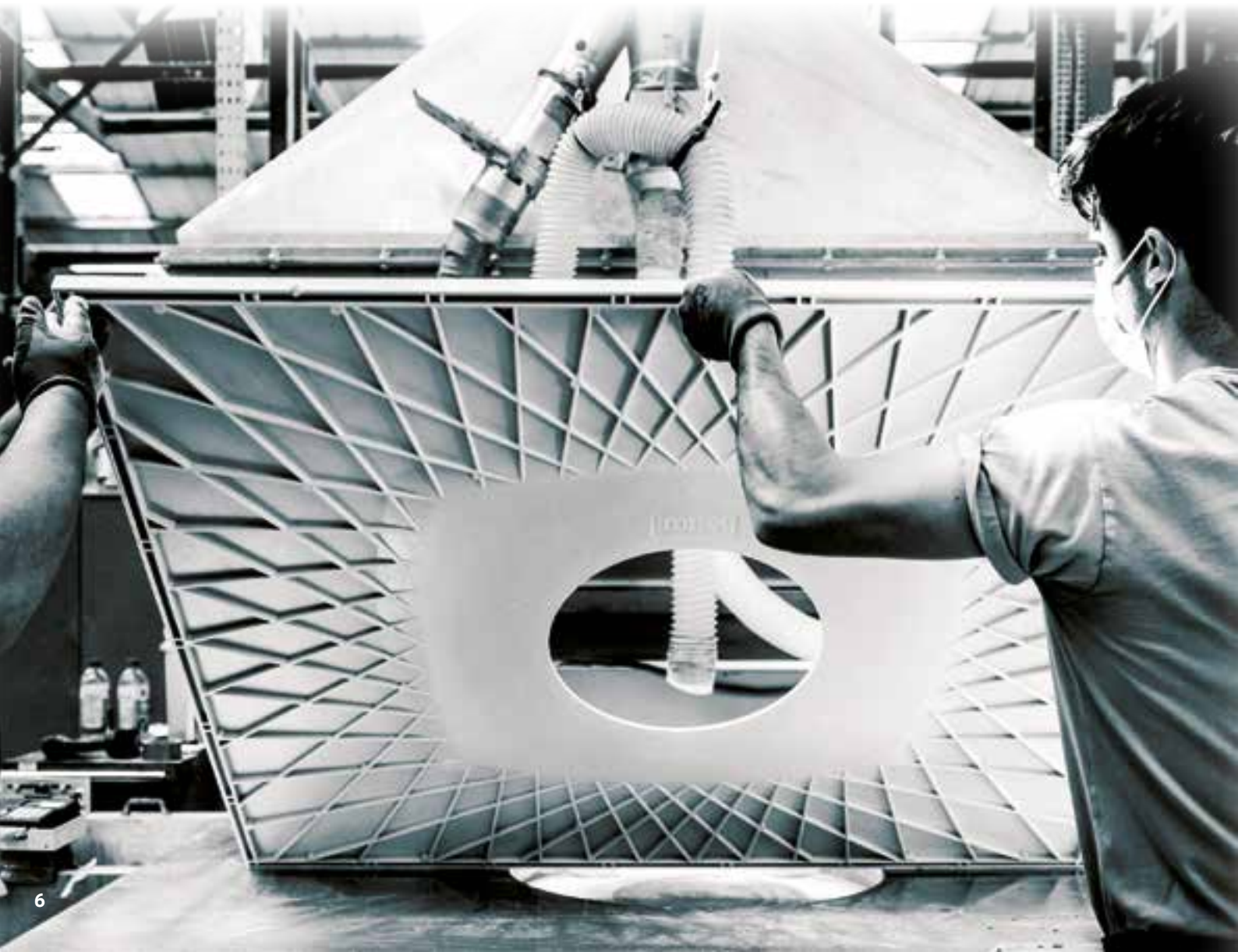



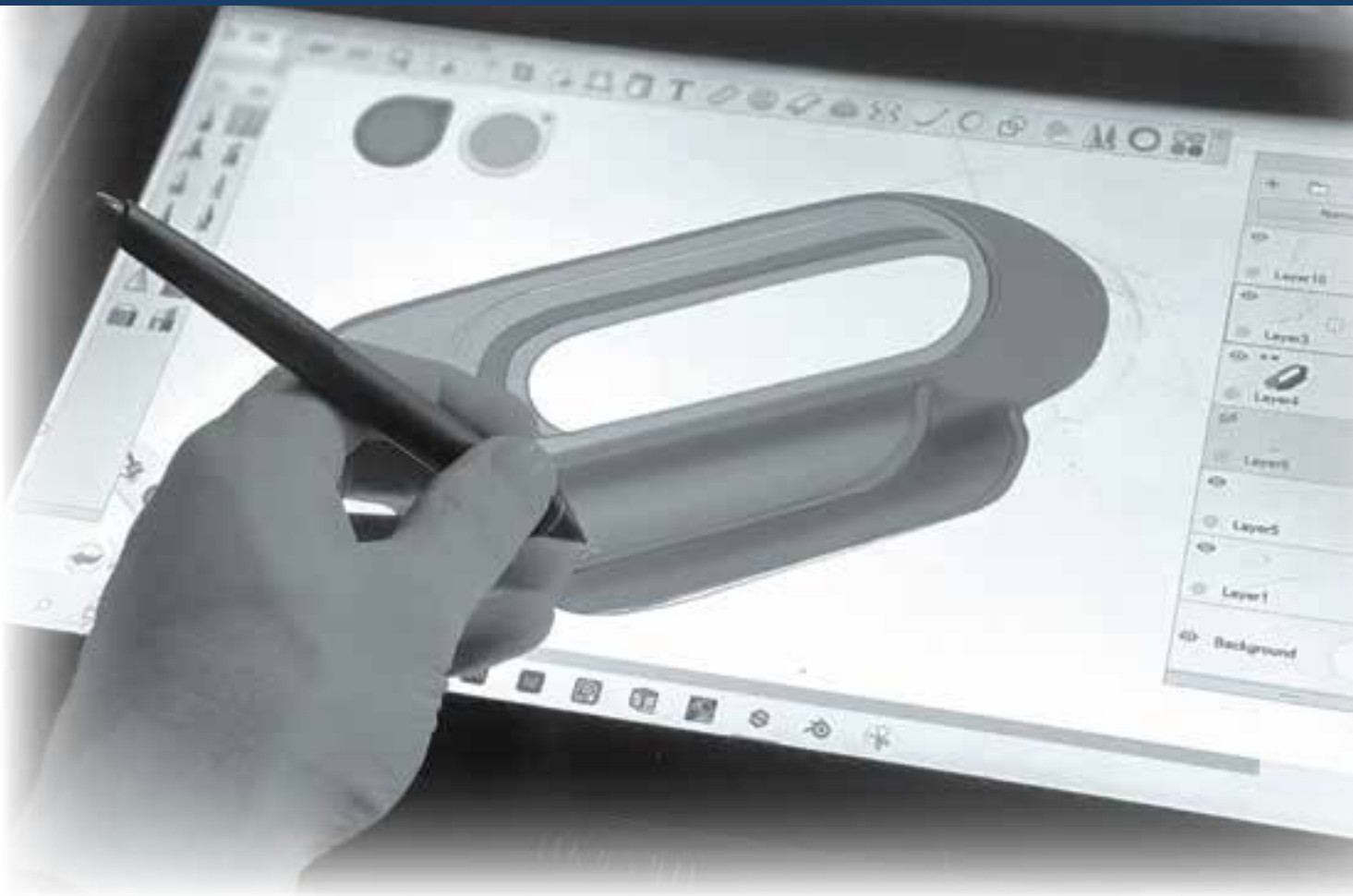

## Research & Development in Ilton

At Impey, we pride ourselves on leading the way in innovation for wetrooms and accessible bathrooms. As experts in healthcare showering, our easy-access solutions are high-performance, watertight and can be easily fitted into an existing bathroom, offering complete showering

freedom. Combining enhanced functionality and improved performance with stylish and contemporary design, it is simple to create a tailored showering space that is modern, attractive and caters to exact mobility requirements.



# Shower Planning Guide

## Step 1: Floor

### Wetroom Floor Formers

Creating 100% level-access on wood or concrete floors

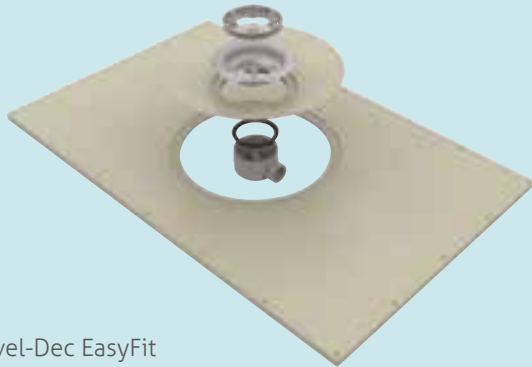

Level-Dec EasyFit  
Pages 12 - 15

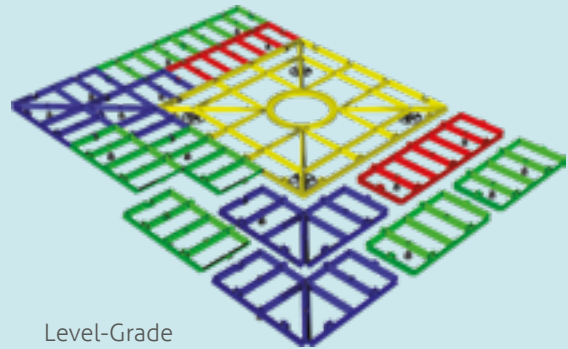

Level-Grade  
Pages 16 - 17

### Shower Trays

Enabling showering on an unbreachable floor



Radiate  
Pages 20 - 23



Mendip  
Pages 24 - 27

### Low Level Shower Trays

An alternative to wetroom floor formers



Mantis  
Pages 30 - 33



Slimline  
Pages 34 - 37



## Step 2: Drainage

Waste fittings come as standard with all Impey wetroom floor formers and shower trays, but we also offer alternative options including pumped and slimline drainage. Pages 38 - 41



Gravity drain for floor formers



Slim+ drain for floor formers



Gravity drain for shower trays



Pumped drain for shower trays

## Step 3: Shower Doors, Panels, Curtains and Screens

Once you have selected the size of wetroom floor former or shower tray you can then choose from a wide range of hinged folding or sliding doors as well as shower panels, curtains and freestanding carer screens.

Half Height Doors  
Pages 44 - 49



**NEW**

Double Bi-Fold  
Doors with  
Coving Profile  
Pages 50 - 51

Available for Corner  
and Alcove installation



Shower Panels,  
Shower  
Curtains and  
Freestanding  
Carer Screens  
Pages 52 - 57



## Step 4: Personalise

Customise your showering space further by adding a shower seat or bench in a range of colours, modular grab rails to suit your space and a wide selection of thermostatic showers to best fit your requirements.

Shower Seats  
Pages 58 - 65



Grab Rails, Hand Rails  
& Accessories  
Pages 66 - 71



Boston Comfort & Safety Range  
Pages 72 - 73

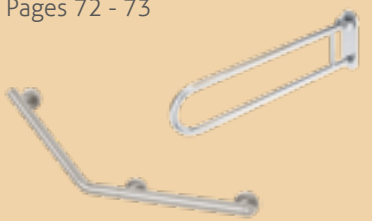

Mixer Showers  
Page 76

Electric  
Showers  
Pages 77 - 79



Showers &  
Waste Pump  
Kits



Pages 80 - 83

Toilets and Bathroom  
Accessories  
Pages 84 - 87



# Wetroom Floor Formers

## Creating 100% level-access on concrete and wooden floors

Commonly known as wetroom trays or wetroom floor formers, these products act as floorboard replacements with a pre-formed gradient to a square drainage point which allows for the creation of a level-access showering space. Wetroom floor formers are then covered in vinyl flooring.

### Level-Dec EasyFit

Pages 12 - 15

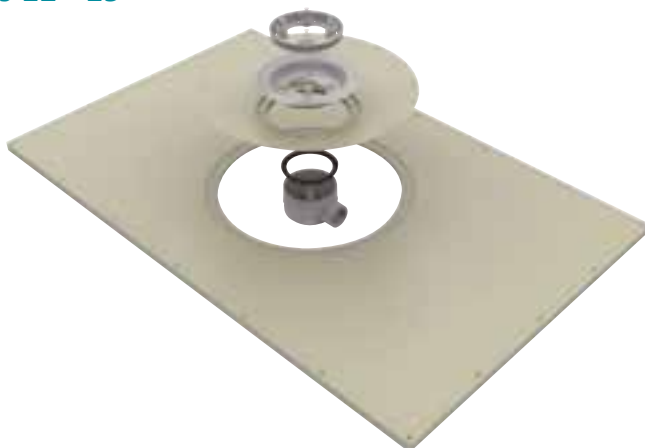

### Level-Grade

Pages 16 - 17

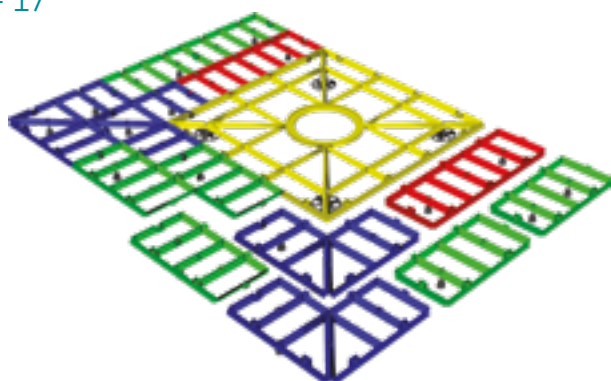

For advice and support on any of our products, call our Technical team on 01460 256080 or visit [www.impeyshowers.com](http://www.impeyshowers.com)



# Wetroom Floor Formers

## Level-Dec EasyFit

A product specifically designed for vinyl installations

Created by Impey, our patented, Level-Dec EasyFit floor former has continually developed and evolved as a product, and consistently resulted in an improved offering. A product designed to be easier to install and service, and care for the vinyl overtime - providing a longer lasting wetroom.

Level-Dec EasyFit wetroom floor formers are the easiest and most reliable way to create the gradient for efficient drainage in a wetroom floor.



Lifetime Guarantee details on Page 94



Made in the UK. See Pages 4 - 7

- Ideal for wooden or concrete floors
- Quick and easiest former to install on the market
- No under boarding required\*
- Easy to cut with a standard handsaw to fit your exact space requirements
- Easy to drill to provide additional screw fixing holes

\*For joists under 415mm centre to centre spacing

### 4 gradients leading to the drain

1:40 gradient across the whole surface down to the drain

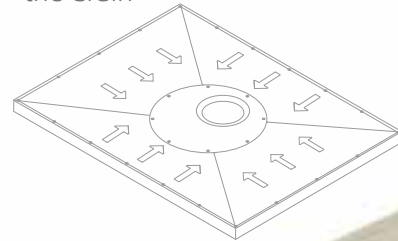

### Strong and rigid design

The underside spoke pattern provides increased rigidity to the structure of the floor former allowing it to support up to 300kg

Registered design.

EU Registration number 001 377 002.

001 346 621.





**Supplied with a UTVG01/H vinyl floor gully horizontal outlet as standard**

Alternative drainage options available. See Page 39



**Award-winning 360° rotating drain**

Makes installation even easier - the drainage point can be adjusted to avoid any joists and assist in linking up to existing drainage

Patented design. Patent number: GB 2 431 341.



**22mm thick**

The overall thickness is the same depth as the most commonly used flooring materials providing a level-access finish



View Level-Dec EasyFit installation video

# Wetroom Floor Formers

## Level-Dec EasyFit



Revolutionary 360° rotating drain by Impey

The Level-EasyFit rotating drain plate can spin 360° to any position to avoid all underfloor wetroom obstructions such as joists.

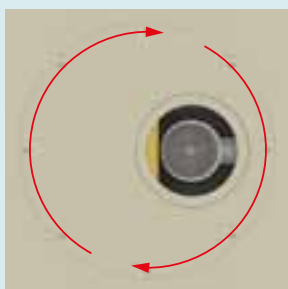

Simply place the Level-Dec EasyFit where it will be installed and if the drain aperture interferes with a joist, just rotate the centre section until it is clear and fit the trap.

Making installation even easier.

- No under boarding required.
- The location of joists within timber floors no longer presents a problem, because the Level-Dec EasyFit includes a revolutionary drainage feature that allows the installer to rotate the drainage point through 360° to any position in order to avoid the joist, standard joist spacing is 415mm.
- If you need to trim or cut to avoid an obstruction it can be cut with a universal hand saw and drilled to provide additional screw fixing holes.

All Level-Decs are 22mm thick at the outer rim to be the same depth as most commonly used flooring materials. Supplied with a UTVG01/H Vinyl Floor Gully Horizontal Outlet as standard. For alternative drainage see Page 39.



NEW

All sizes and measurements are shown in mm

800  
Adjustable (320 to 480)

800  
Adjustable (320 to 480)

**Size: 800 x 800**  
For vinyl floors Code: LDE8080GRY

900  
Adjustable (370 to 530)

900  
Adjustable (370 to 530)

**Size: 900 x 900**  
For vinyl floors Code: LDE9090GRY

1000  
Adjustable (420 to 580)

1000  
Adjustable (420 to 580)

**Size: 1000 x 1000**  
For vinyl floors Code: LDE1010GRY

1200  
Adjustable (520 to 680)

750  
Adjustable (295 to 455)

**Size: 1200 x 750**  
For vinyl floors Code: LDE1275GRY

1200  
Adjustable (520 to 680)

900  
Adjustable (370 to 530)

**Size: 1200 x 900**  
For vinyl floors Code: LDE1290GRY

1200  
Adjustable (520 to 680)

1200  
Adjustable (520 to 680)

**Size: 1200 x 1200**  
For vinyl floors Code: LDE1212GRY

1300  
Adjustable (570 to 730)

800  
Adjustable (320 to 480)

**Size: 1300 x 800**  
For vinyl floors Code: LDE1380GRY

1400  
Adjustable (620 to 780)

900  
Adjustable (370 to 530)

**Size: 1400 x 900**  
For vinyl floors Code: LDE1490GRY

1500  
Adjustable (670 to 830)

800  
Adjustable (320 to 480)

**Size: 1500 x 800**  
For vinyl floors Code: LDE1580GRY

1500  
Adjustable (670 to 830)

1200  
Adjustable (520 to 680)

**Size: 1500 x 1200**  
For vinyl floors Code: LDE1512GRY

1700  
Adjustable (770 to 930)

750  
Adjustable (295 to 455)

**Size: 1700 x 750**  
For vinyl floors Code: LDE1775GRY

1850  
Adjustable (845 to 1005)

900  
Adjustable (370 to 530)

**Size: 1850 x 900mm**  
For vinyl floors Code: LDE18590GRY



See Floor and Door Options on Pages 50 - 51 for a wetroom



View Level-Dec EasyFit installation video

# Wetroom Floor Formers

## Level-Grade

### Colour coded modular sections

Level-Grade provides a quick and easy way of creating the perfect wetroom floor gradient for concrete solid floors.

Colour coded modular sections quickly click together to form a matrix that you simply fill with screed.

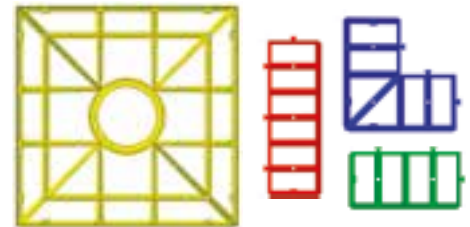

Lifetime Guarantee details on Page 94



Made in the UK. See Pages 4 - 7

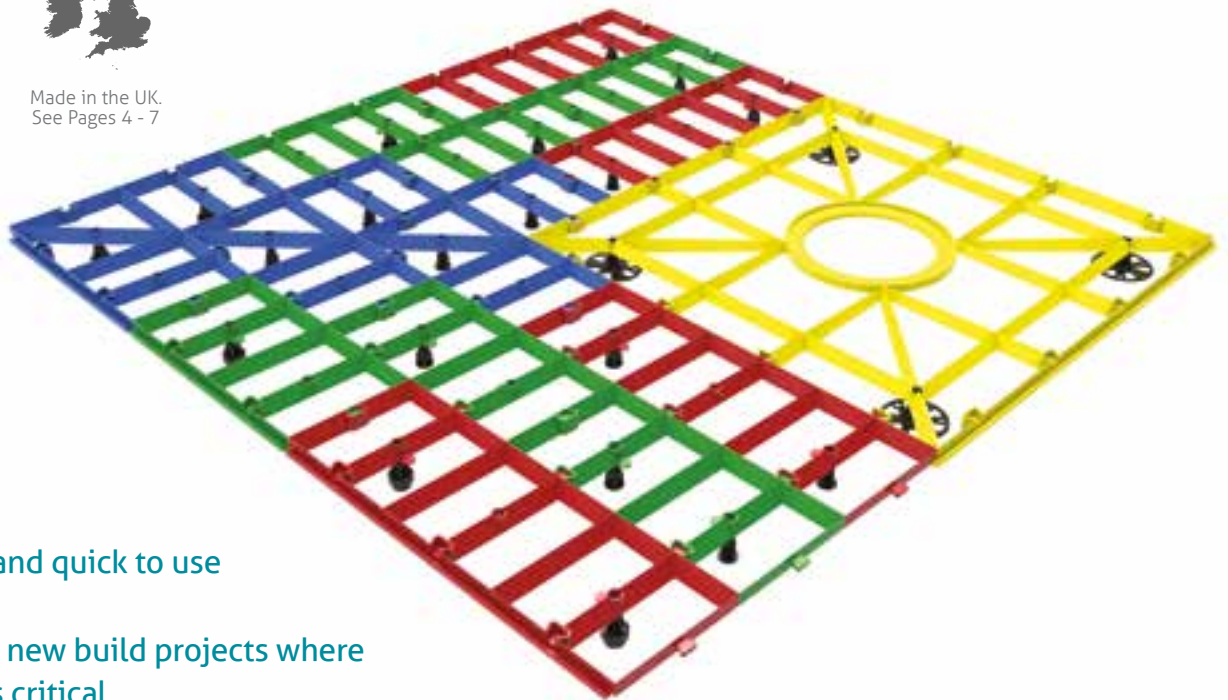

- Precise and quick to use
- Ideal for new build projects where timing is critical
- Guarantees the perfect wetroom floor gradient every time
- Eliminates any chance of water pooling
- Available in 8 standard sizes
- Supplied with a UTVG01/H vinyl floor gully horizontal outlet as standard



When installing, please refer to the fitting instructions, which are included in the pack.



Level-Grade is available in 8 standard sizes.

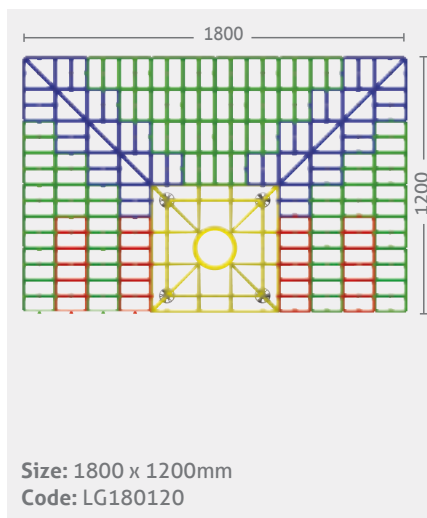
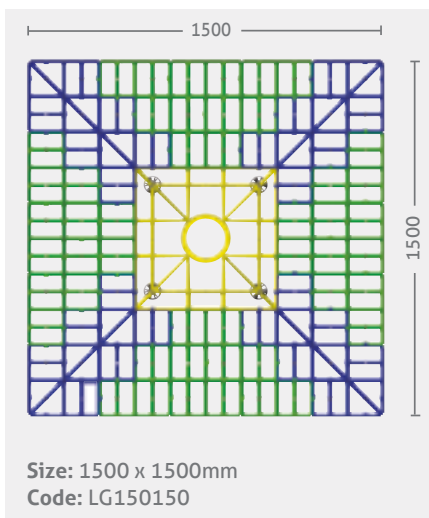
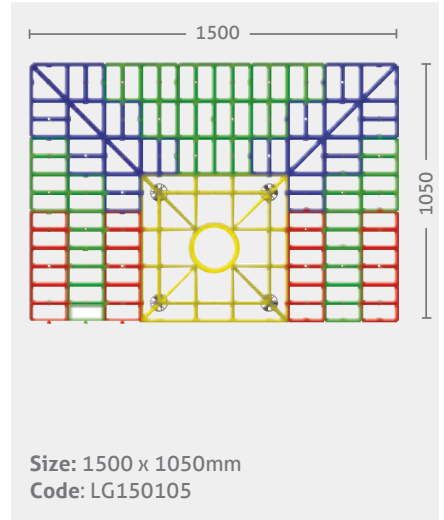
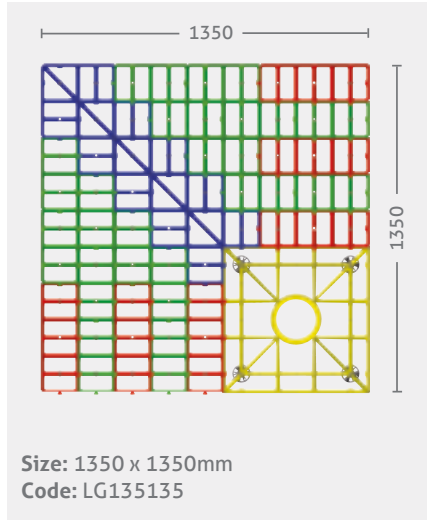
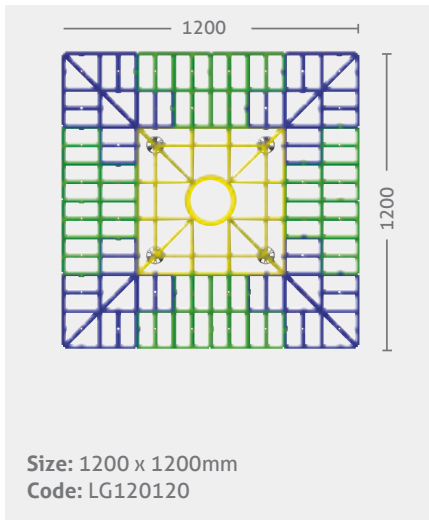
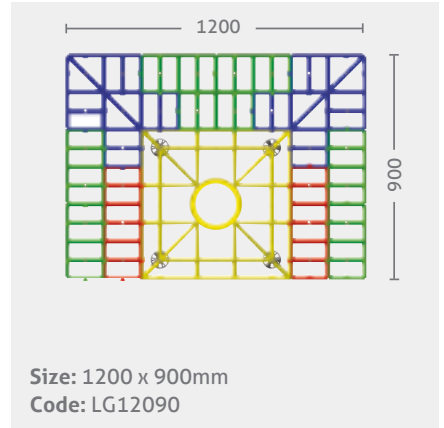
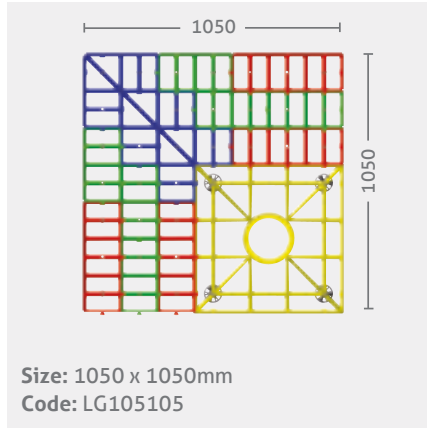
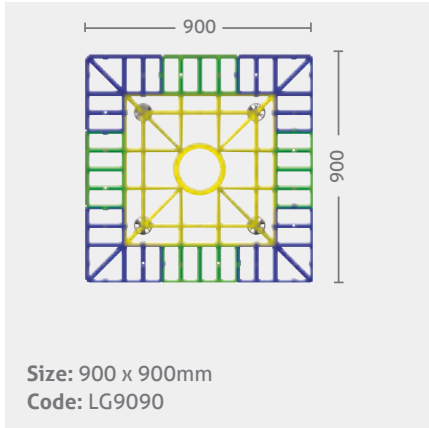

**UTVG01/H supplied as standard**

Alternative drainage options available. See Page 39

Optional chrome top



We can provide bespoke options, please speak to a member of our Technical team for all advice and support on 01460 256080





## For unbreachable floors

We offer two dedicated shower tray solutions for installing on unbreachable floors. Our Radiate and Mendip models are supplied with dedicated waste fittings within the height of the tray.

Our Radiate range is only 40mm in height and has been designed with integrated pumped drainage whereas our Mendip range is 100mm in height and features a gravity drain.

Both trays are supplied with our high performance tile upstand waterproofing membrane, providing a guaranteed seamless link between tray and tile.

All Shower Trays come complete with a high quality waste fitting.

### Radiate



Pages 20 - 23

### Mendip



Pages 24 - 27



For advice and support on any of our products, call our Technical team on 01460 256080 or visit [www.impeyshowers.com](http://www.impeyshowers.com)

# Shower Trays

## Radiate

Radiate has been specifically designed for situations where gravity drainage is not possible

Radiate instantly solves the problem of fitting shower trays on unbreachable floors with this pumped solution.

A Radiate Shower Tray can be installed within high-rise developments and is ideally suited for use with an electric shower.



CE Tested complies with BS EN 14527



Lifetime Guarantee details on Page 94



Made in the UK. See Pages 4 - 7

Acoustically tuned quiet waste

Advanced ultra quiet drainage

Supplied with dedicated pumped drain outlet as standard

See design details on Page 41



- Quick and easy to install
- Reduced slip, matte finish
- Self-adhesive tile upstand included. Guarantees a watertight seal to wall tiling
- Available in 14 sizes including 2 bath replacement trays
- Easy to clean surface and gully
- Designed specifically for pumped drainage
- Designed to work with Whale Switch Connect, Direct Connect and Instant Match waste pumps
- We'd recommend fitting alongside our market leading folding/sliding half height shower doors and glass screens





Flow rate for all Radiate tray sizes is max 8.5 l/min\*\*

Actual height 40mm

**Access friendly**

Only 40mm high and with compatible ramps available.

Low enough to offer easy access to those with limited mobility into the showering area

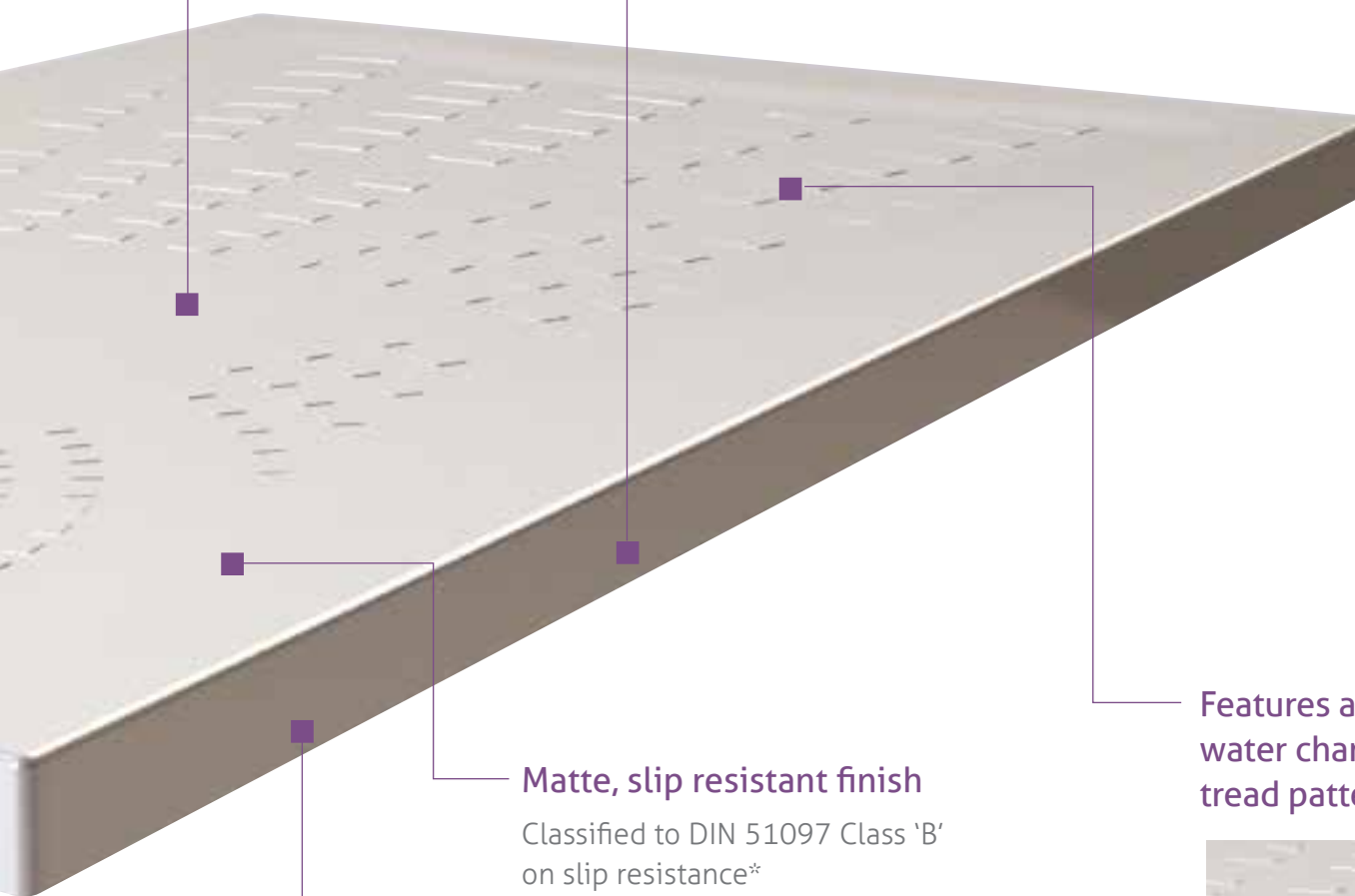

Features a unique water channelling tread pattern



**Matte, slip resistant finish**

Classified to DIN 51097 Class 'B' on slip resistance\*

**Exit pipework from any side of the tray**

Multiple waste outlet locations, within the height of the tray

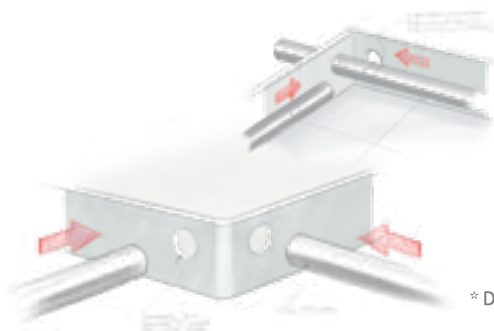

\* DIN 51097:1992 Determination of anti-slip properties; wet loaded barefoot areas; walking method; ramp test  
 \*\* 11 l/min if used as gravity waste

# Shower Trays

## Radiate

Radiate delivers everything you're looking for to solve all the problems associated with unbreachable floors.

The pumped waste fitting, concealed perfectly within the underside of the tray, ensures that any water draining to the gully is quickly and efficiently fed to the waste pump, with a maximum flow rate of 11 l/m with a gravity waste, 8.5 l/m with the provided pump waste.

The tray features a unique water channelling tread pattern which has a reduced slip anti-shine surface. Classified to DIN 51097 Class 'B' on slip resistance\*, Radiate sets a new level of care and design.

It's ideal for multi-storey developments and is compatible with pumped waste options including Whale Switch Connect, Direct Connect and Instant Match waste pumps.

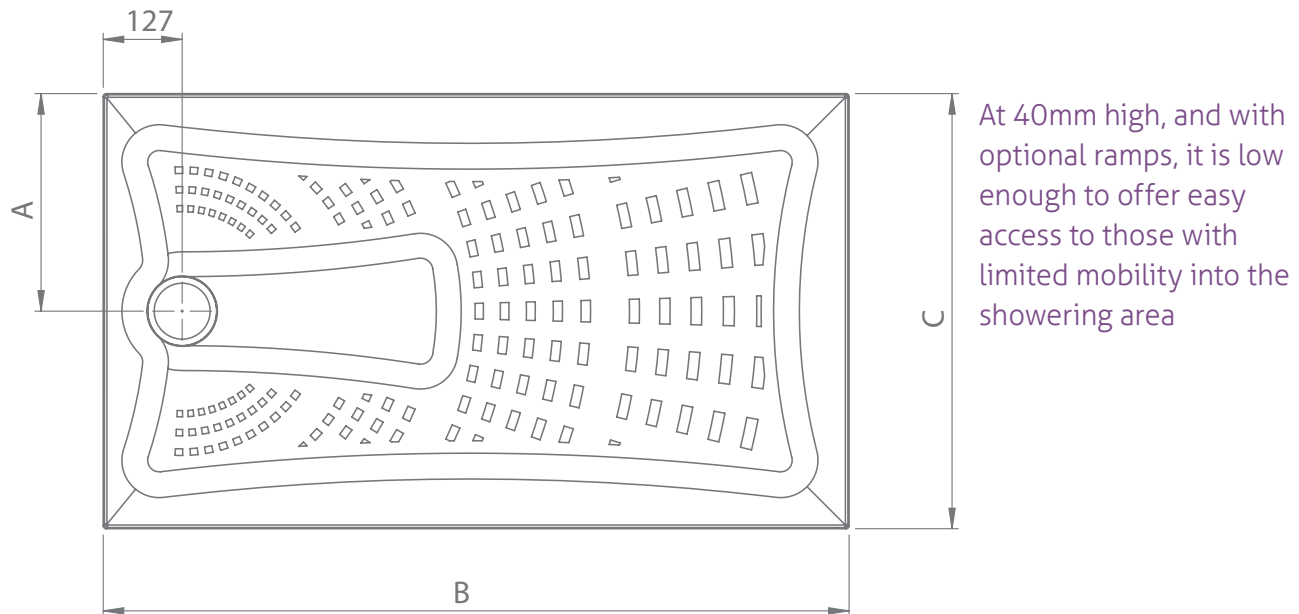

### Radiate sizes and codes

Code	Size (mm)	Dimensions (mm)
RDT9090/P	900 x 900	(A)450 / (B)900 / (C)900
RDT100100/P	1000 x 1000	(A)500 / (B)1000 / (C)1000
RDT12070/P	1200 x 700	(A)350 / (B)1200 / (C)700
RDT12080/P	1200 x 800	(A)400 / (B)1200 / (C)800
RDT12090/P	1200 x 900	(A)450 / (B)1200 / (C)900
RDT13070/P	1300 x 700	(A)350 / (B)1300 / (C)700
RDT13080/P	1300 x 800	(A)400 / (B)1300 / (C)800
RDT14070/P	1400 x 700	(A)350 / (B)1400 / (C)700
RDT14080/P	1400 x 800	(A)400 / (B)1400 / (C)800
RDT14090/P	1400 x 900	(A)450 / (B)1400 / (C)900
RDT15070/P	1500 x 700	(A)350 / (B)1500 / (C)700
RDT15080/P	1500 x 800	(A)400 / (B)1500 / (C)800
RDT17070/P	1700 x 700	(A)350 / (B)1700 / (C)700
RDT17080/P	1700 x 800	(A)400 / (B)1700 / (C)800

### Ramp Kits

Code	Description
RDRKIT	Ramp Kit
RDRCS	Ramp Corner Section

Radiate is supplied with a pumped drain as standard.

See Floor and Door Options on Pages 88 - 93 for a shower tray

# Radiate - Bath Replacement Tray

The ideal solution for bath replacement



Radiate Bath Replacement Trays have been designed so that they can be cut down to fit a wall to wall space where a bath was previously installed.

A conventional multipurpose handsaw can be used to cut the shower tray.

RDTEC70 – 700mm wide  
RDTEC80 – 800mm wide

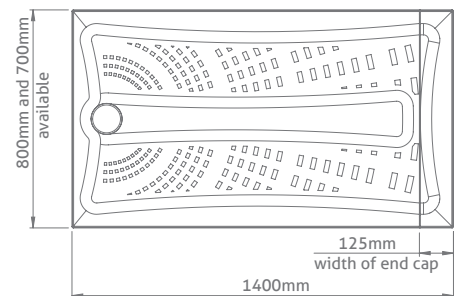
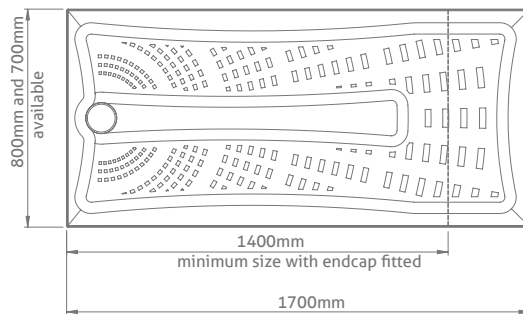

When measuring and cutting the tray please allow for the end cap.

Supplied with dedicated pumped drain outlet  
Details on Page 41



## Self-Adhesive Tiling Upstand

Supplied with high performance tile upstand waterproofing membrane, providing a guaranteed seamless link between tray and tile

Waterproof Self Adhesive Tiling Upstand (3.5m roll - 120mm wide)

Code: US12350



Lifetime Guarantee  
details on Page 94



Made in the UK.  
See Pages 4 - 7

See Floor and Door Options on  
Pages 52 - 55 for a bath replacement tray

# Shower Trays

## Mendip

### Gravity solution for unbreachable floors

Designed for installations where the floor cannot be breached, as is often the case in situations, such as multi-storey apartments. The design of the Mendip Shower Tray portfolio means it is fully self-supporting, so there is no need to bed it down. The waste fitting is housed beneath the tray, which is 100mm high. A sloping Access Ramp and 50mm Half Step are available to provide easier access.

**UK CA** **CE** CE Tested complies with BS EN 14527



Lifetime Guarantee details on Page 94



Made in the UK. See Pages 4 - 7

Inspection cover

Tray depth of 100mm

Actual height 100mm

Supplied with a factory fitted waste trap with swivel outlet for drainage positioning

50mm water seal compliant with building regulations





Slip resistance classified to  
DIN 51097 Class 'A'

Classified to DIN 51097 Class 'A'  
on slip resistance\*

Highly robust  
construction

Compatible with  
a sloping Access  
Ramp or a 50mm  
Half Step to provide  
easier access



\*DIN 51097:1992 Determination of anti-slip properties; wet loaded barefoot areas; walking method; ramp test

# Shower Trays

## Mendip

### Shower Tray with above floor drainage

The Mendip range offers 7 sizes including a Bath Replacement Tray. Flow rate 8-10 l/m depending on the size of shower tray. Multiple waste outlet locations, within the height of the tray. Exit pipework from any side of the tray.



Cut to length version available  
with 2 end caps supplied



For advice and support on any of our products, call our  
Technical team on 01460 256080 or visit [www.impeyshowers.com](http://www.impeyshowers.com)



Size: 900 x 900mm  
Code: MEN501/C



Size: 1000 x 1000mm  
Code: MEN601/C



Size: 1250 x 710mm  
Code: MEN101/C



Size: 1250 x 830mm  
Code: MEN201/C



Size: 1500 x 710mm  
Code: MEN301/C



Size: 1500 x 830mm  
Code: MEN401/C



Size: 1850 x 710mm  
Code: MEN701/C (cut to length version with two end caps supplied - trim with saw)

**Available in a range of sizes:**

- 900 x 900mm      Code: MEN501/C
- 1000 x 1000mm      Code: MEN601/C
- 1250 x 710mm      Code: MEN101/C
- 1250 x 830mm      Code: MEN201/C
- 1500 x 710mm      Code: MEN301/C
- 1500 x 830mm      Code: MEN401/C
- 1850 x 710mm      Code: MEN701/C

### Access Ramp



Size: 900 x 400mm  
Code: MEN/R01

### 50mm Half Step



Size: 720 x 300mm  
Code: MEN/P01



**All Mendip trays include a factory fitted waste trap**  
The compact above ground trap has a swivel outlet for drainage positioning. It has a 40mm outlet and a 50mm water seal. Designed to be used with single instantaneous feed with electric showers and medium flow mixer valves.



### Self-Adhesive Tiling Upstand

Supplied with high performance tile upstand waterproofing membrane, providing a guaranteed seamless link between tray and tile

Waterproof Self Adhesive Tiling Upstand (3.5m roll - 120mm wide)

Code: US12350



Lifetime Guarantee details on Page 94



Made in the UK. See Pages 4 - 7

See Floor and Door Options on Pages 52 - 55 for a shower tray

# Low Level Shower Trays

## From as low as 24mm

We offer a wide range of shower trays to suit all types of applications. Our Low Level Shower Trays are built to accommodate both gravity and pumped drainage whilst also providing easy access with compatible ramps.

### Mantis

Pages 30 - 33



### Slimline

Pages 34 - 37



For advice and support on any of our products, call our Technical team on 01460 256080 or visit [www.impeyshowers.com](http://www.impeyshowers.com)





# Low Level Shower Trays

## Mantis

The only 24mm high shower tray on the market

At just 24mm in height, the Mantis Shower Tray delivers a significant advancement in low level showering specification. Tested in accordance with the same DIN 51097\* Class 'B' high slip safety rating as our Radiate Shower Tray.

**UK CA** **CE** CE Tested complies with BS EN 14527



Lifetime Guarantee details on Page 94



Made in the UK. See Pages 4 - 7

End centre drain position

Specially designed water channelling system

Matte finish for additional grip

- Step in height of only 24mm - only shower tray on the market of this height
- 12 sizes in total including 2 bath replacement trays
- Flow rate: 11 l/min
- Easy clean surface
- Perfect for use with electric showers
- Unhanded tray
- Versatile installation - can be recessed into the floor to provide complete level-access

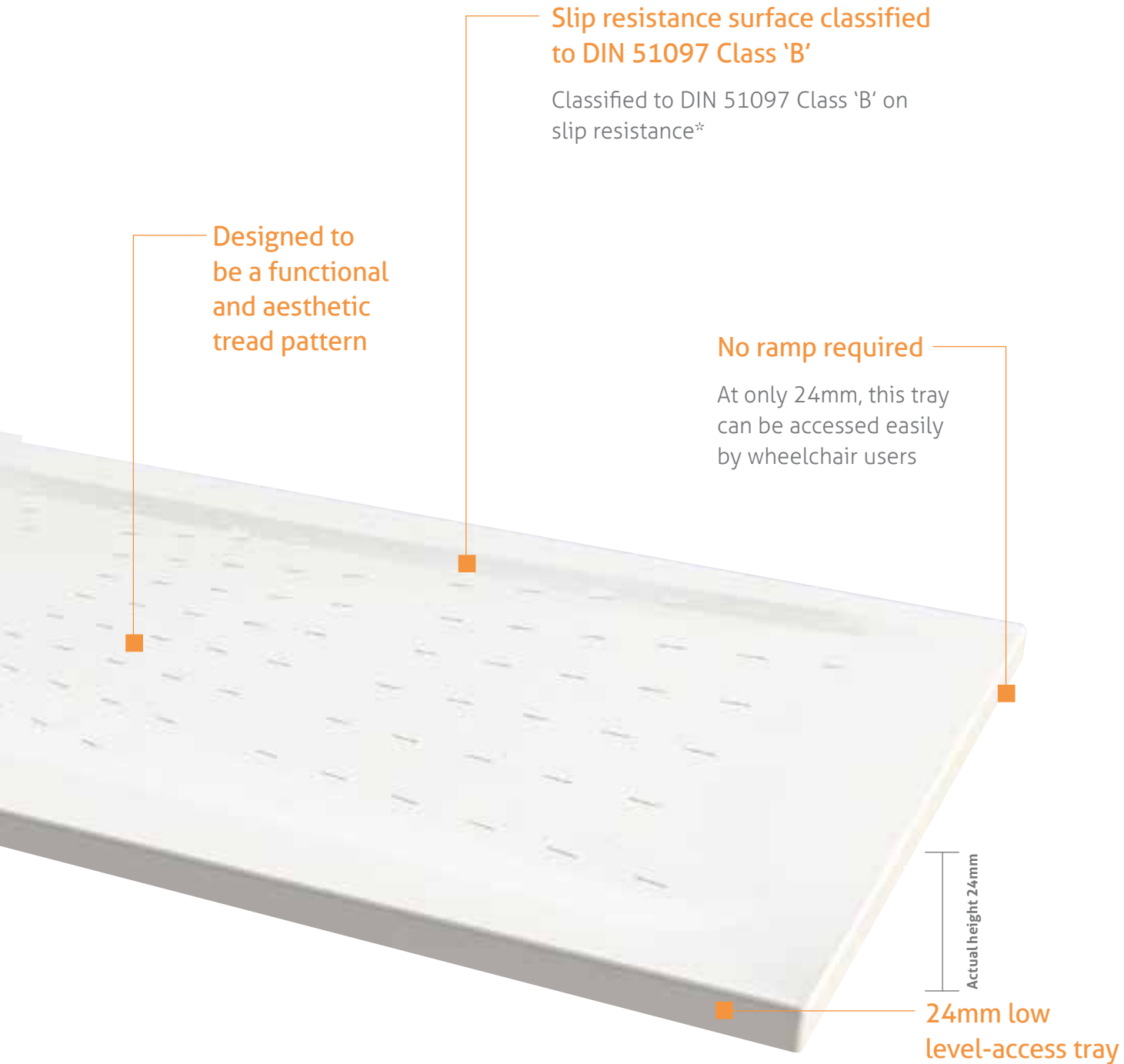

**Slip resistance surface classified to DIN 51097 Class 'B'**

Classified to DIN 51097 Class 'B' on slip resistance\*

**Designed to be a functional and aesthetic tread pattern**

**No ramp required**

At only 24mm, this tray can be accessed easily by wheelchair users

Actual height 24mm

**24mm low level-access tray**

**All Mantis trays come supplied with tiling upstand and waste**



All supplied with 90mm trap.  
**Code: IMOR/HKIT**  
Alternatives available see Page 40



**Self-Adhesive Tiling Upstand**

Supplied with high performance tile upstand waterproofing membrane, providing a guaranteed seamless link between tray and tile

Waterproof Self Adhesive Tiling Upstand (3.5m roll - 120mm wide)

**Code: US12350**

\*DIN 51097:1992 Determination of anti-slip properties; wet loaded barefoot areas; walking method; ramp test.

# Low Level Shower Trays

## Mantis

The Mantis Shower Tray is the industry's first ultra slim shower tray

Developed after direct consultation with Occupational Therapists and Contractors, the Mantis Shower Tray offers the perfect solution in situations where a floor former cannot be installed. Mantis can be installed above or below ground to suit specific locations, has a flow rate of 11 litres per minute, due to its water channeling tread pattern, and is supplied with a tile upstand and compatible gravity drainage.

Similar to Radiate, Mantis has been designed with an easy to clean, slip resistant matte finish, that qualifies to DIN 51097 Class 'B' on slip resistance\*. This provides an increased grip for users in wet, soapy conditions, compared to more traditional shower trays. Mantis is available in 12 sizes including 2 bath replacement sizes which can also be cut down to a minimum length of 1400mm supplied end caps to ensure a perfect fit. Bedding down of the tray is recommended.

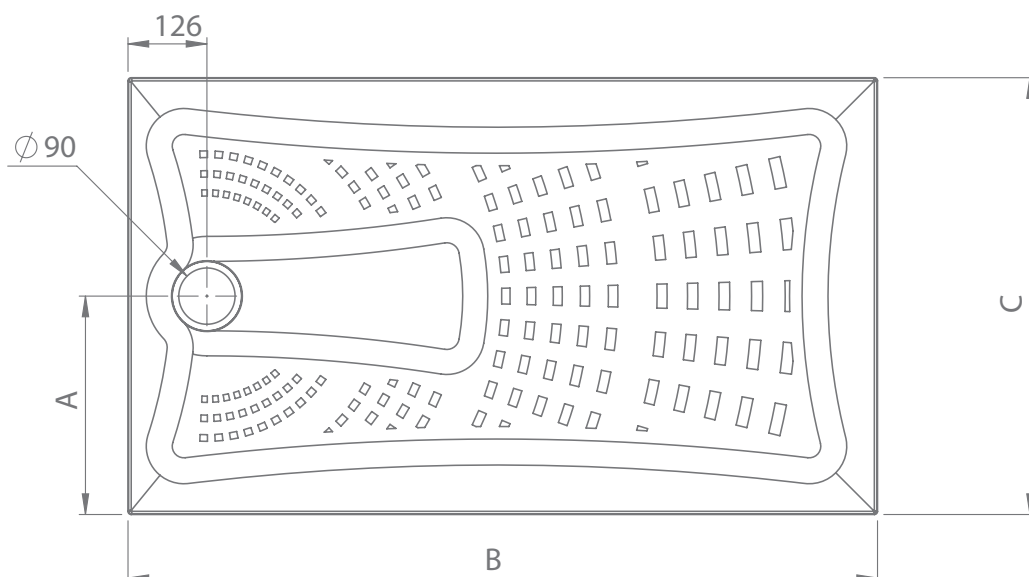

### Mantis sizes and codes

Code	Size (mm)	Dimensions (mm)
MTS9090	900 x 900	(A)449 / (B)900 / (C)900
MTS100100	1000 x 1000	(A)499 / (B)1000 / (C)1000
MTS12070	1200 x 700	(A)349 / (B)1200 / (C)700
MTS12080	1200 x 800	(A)399 / (B)1200 / (C)800
MTS13070	1300 x 700	(A)349 / (B)1300 / (C)700
MTS13080	1300 x 800	(A)399 / (B)1300 / (C)800
MTS14070	1400 x 700	(A)349 / (B)1400 / (C)700
MTS14080	1400 x 800	(A)399 / (B)1400 / (C)800
MTS15070	1500 x 700	(A)349 / (B)1500 / (C)700
MTS15080	1500 x 800	(A)399 / (B)1500 / (C)800
MTS17070	1700 x 700	(A)349 / (B)1700 / (C)700
MTS17080	1700 x 800	(A)399 / (B)1700 / (C)800

Mantis is supplied with horizontal outlet drain as standard.

See Floor and Door Options on Pages 52 - 55 for a shower tray

\*DIN 51097:1992 Determination of anti-slip properties; wet loaded barefoot areas; walking method; ramp test.



# Mantis - Bath Replacement Tray

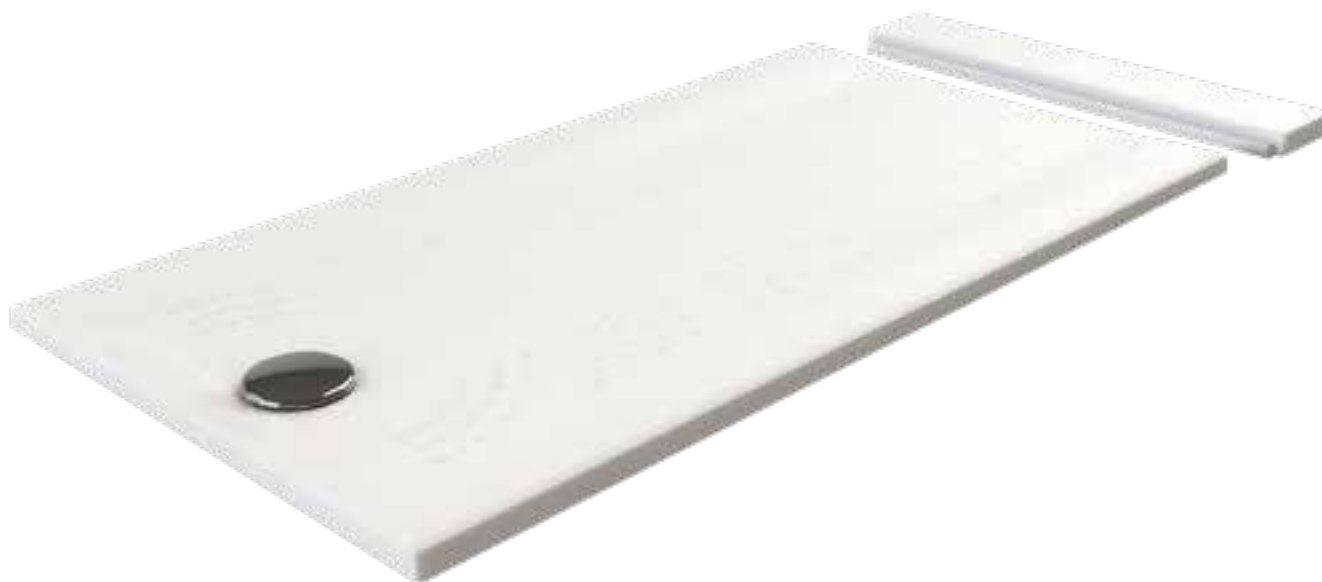

Mantis Bath Replacement Trays have been designed so that they can be cut down to fit a wall to wall space where a bath was previously installed.

A conventional multi purpose handsaw can be used to cut the shower tray.

MTSEC70 – 700mm wide  
MTSEC80 – 800mm wide

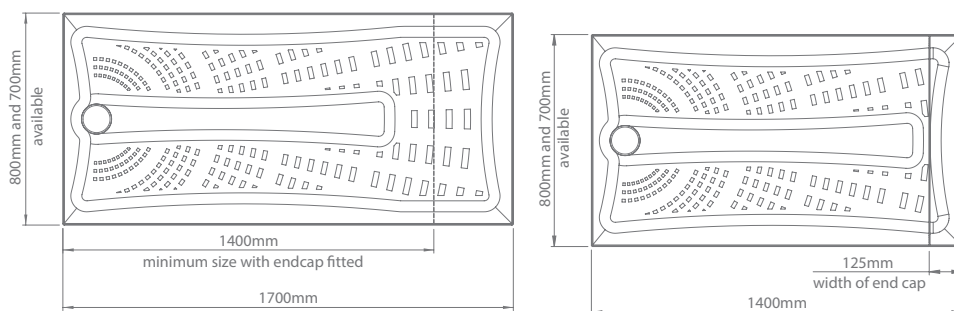

When measuring and cutting the tray please allow for the the end cap

## All Mantis trays come supplied with tiling upstand and waste



All supplied with 90mm trap.  
**Code: IMOR/HKIT**  
Alternatives available see Page 40



### Self-Adhesive Tiling Upstand

Supplied with high performance tile upstand waterproofing membrane, providing a guaranteed seamless link between tray and tile

Waterproof Self Adhesive Tiling Upstand (3.5m roll - 120mm wide)

**Code: US12350**



Lifetime Guarantee details on Page 94



Made in the UK. See Pages 4 - 7

See Floor and Door Options on Pages 52 - 55 for a bath replacement tray

# Low Level Shower Trays

## Slimline

Our most versatile high performance shower tray

The 35mm high Slimline Shower Tray incorporates an ergonomic slip resistant design with industry leading flow rates of up to 36 litres per minute.

The tray can be recessed into the floor or fitted with a ramp around the entire perimeter for easier access.



CE Tested complies with BS EN 14527



Lifetime Guarantee  
details on Page 94

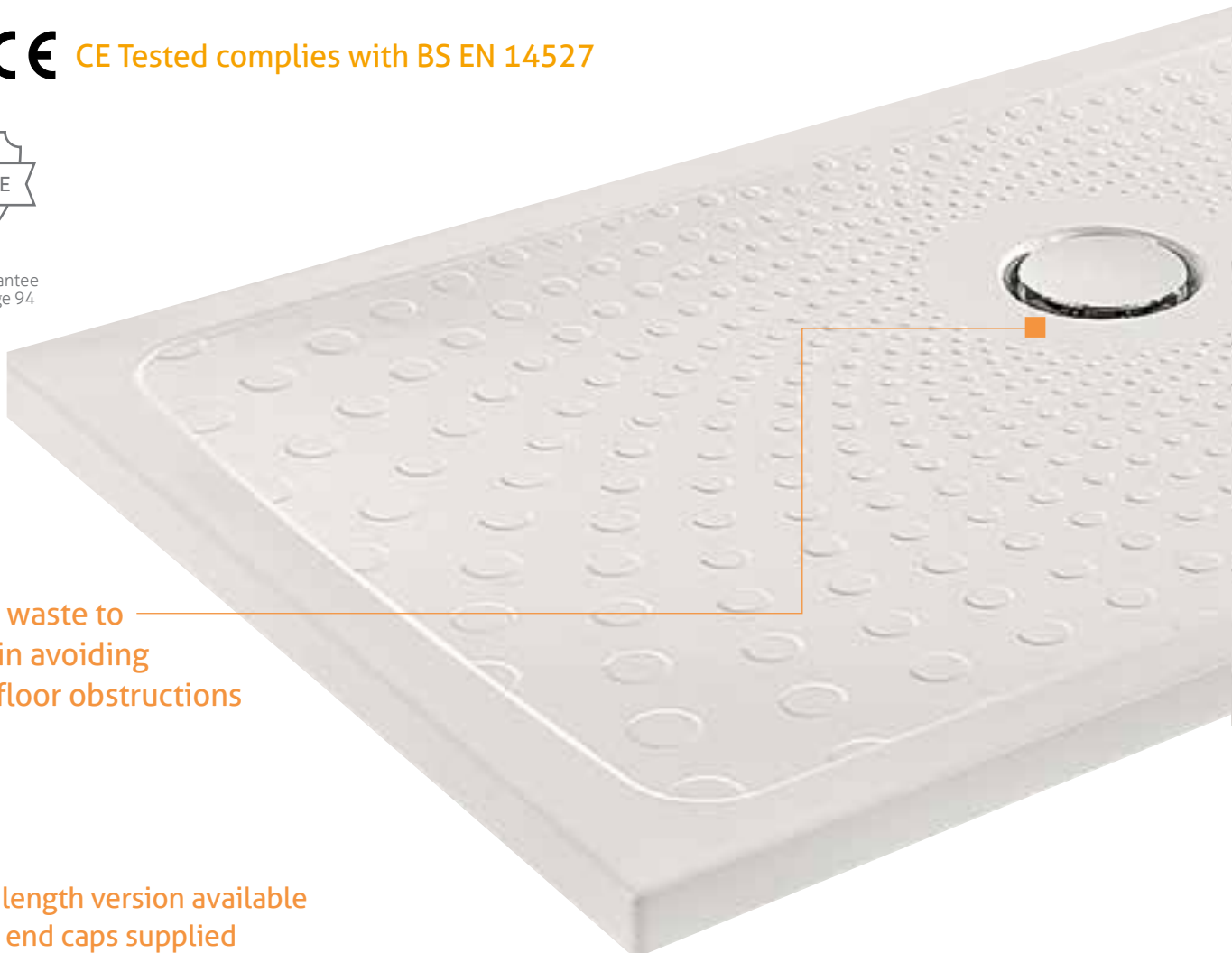

Offset waste to assist in avoiding underfloor obstructions

- Cut to length version available with 2 end caps supplied
- Maximum flow rate of up to 36 litres per minute
- Available in 9 sizes + 3 bath replacement trays
- Versatile installation - can be recessed into the floor to provide 100% level-access
- Compatible with all Impey shower doors and glass panels
- Easy clean surface
- Non-handed design
- Compatible with Gravity, Pumped and Slimline drainage options
- Service ducting available to conceal pipework making installation easier as there is no need to chase out the walls or floors

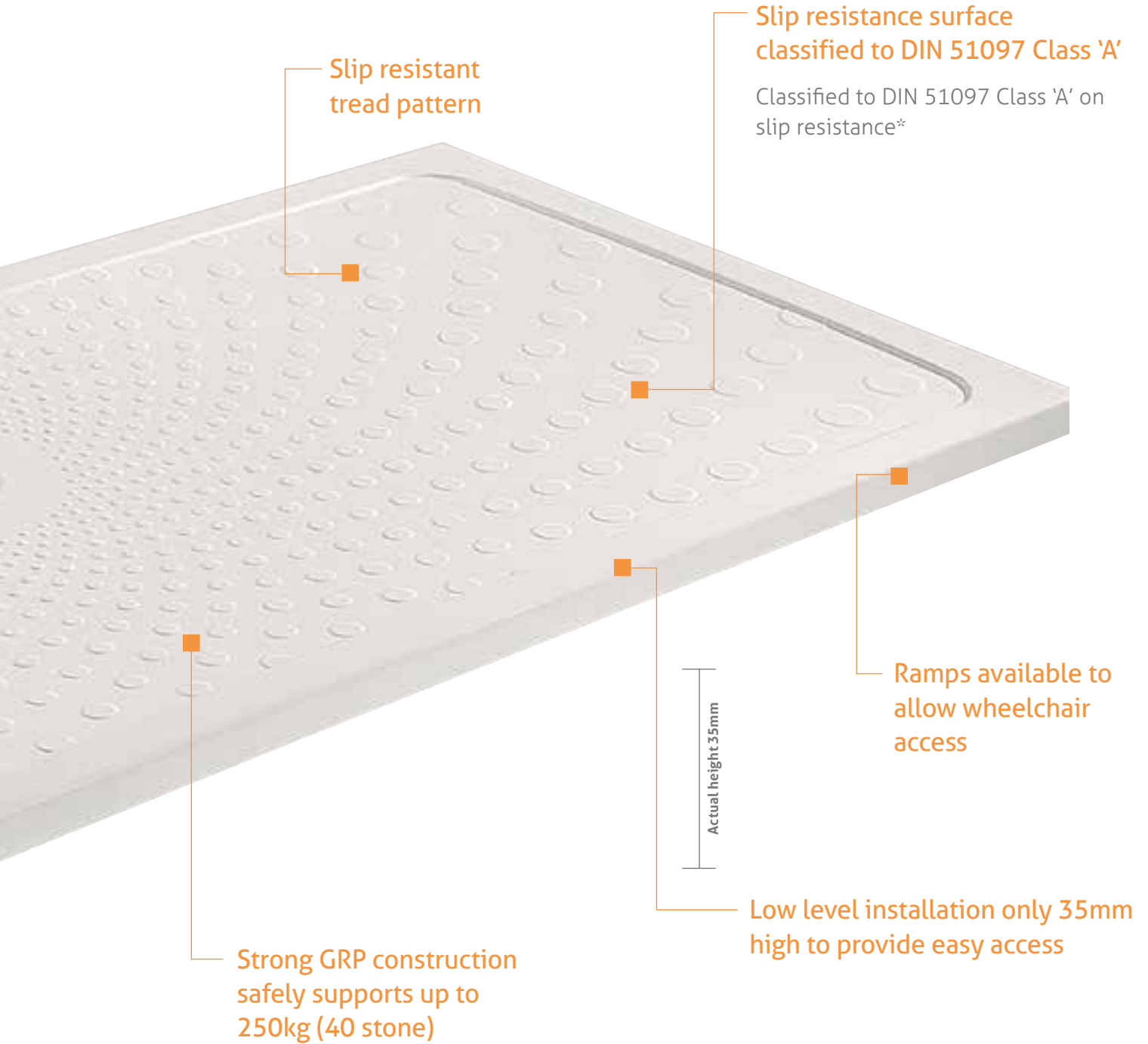

**All Slimline trays come supplied with tiling upstand and waste**



All supplied with 90mm trap.  
**Code:** IMOR/HKIT  
Alternatives available, see Page 40



**Self-Adhesive Tiling Upstand**

Supplied with high performance tile upstand waterproofing membrane, providing a guaranteed seamless link between tray and tile

Waterproof Self Adhesive Tiling Upstand (3.5m roll - 120mm wide)

**Code:** US12350

\*DIN 51097:1992 Determination of anti-slip properties; wet loaded barefoot areas; walking method; ramp test.

# Low Level Shower Trays

## Slimline

This modern, stylish slimline tray from Impey offers a low-level installation at only 35mm high.

They can also be recessed into the floor or fitted with a ramp around the entire perimeter for easier access. Robust GRP construction will support up to 250kg (40 stone). Service ducting to conceal pipe work is available, which makes installation easier by removing the need to chase out the floor or walls.

Flow rate up to 36 litres per minute depending on the size of Shower Tray



Size: 800 x 800mm  
Code: SL358080

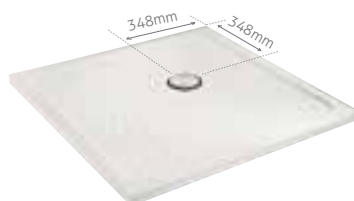

Size: 900 x 900mm  
Code: SL359090

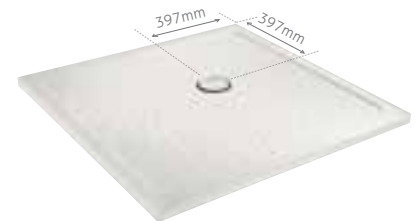

Size: 1000 x 1000mm  
Code: SL35100100

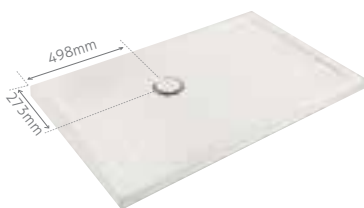

Size: 1200 x 750mm  
Code: SL3512075



Size: 1200 x 900mm  
Code: SL3512090

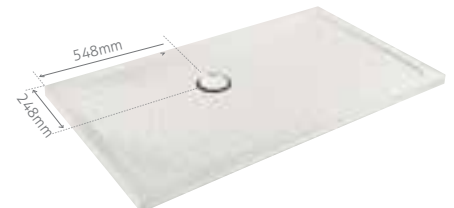

Size: 1300 x 700mm  
Code: SL3513070



Size: 1300 x 750mm  
Code: SL3513075

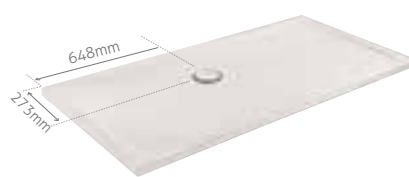

Size: 1500 x 750mm  
Code: SL3515075

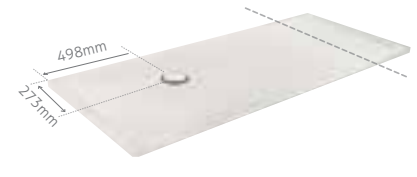

Size: 1700 x 750mm  
Code: SL3517075/CWEC  
(Can be cut to length. End cap supplied)

### Ramp Kit

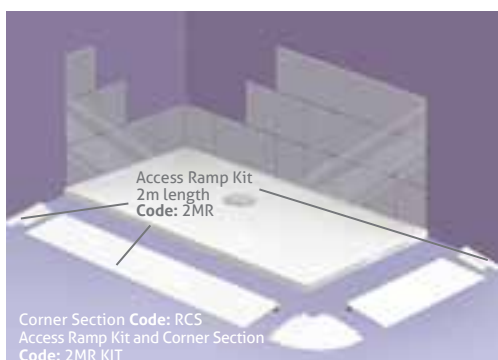

### Versatile installation



Can be recessed into floor for level-access



# Slimline Bath Replacement Tray



Lifetime Guarantee details on Page 94

These have been specially designed to cover all the sizes required to replace a bath, whilst still offering a low-level installation at only 40mm high.

They can also be recessed into the floor. Robust GRP construction will support up to 250kg (40 stone).

- Features a matte, slip resistant surface
- Flow rate up to 36 litres per minute depending on the size of shower
- Classified to DIN 51097 Class 'B' on slip resistance\*

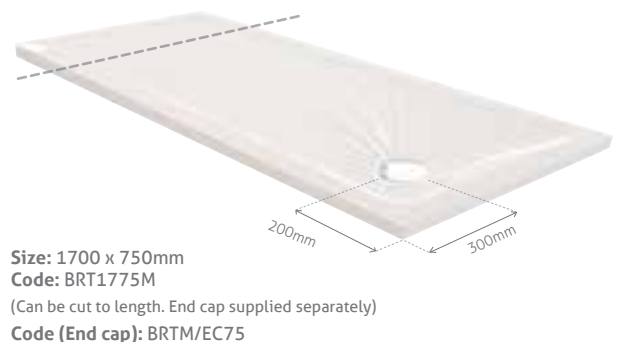
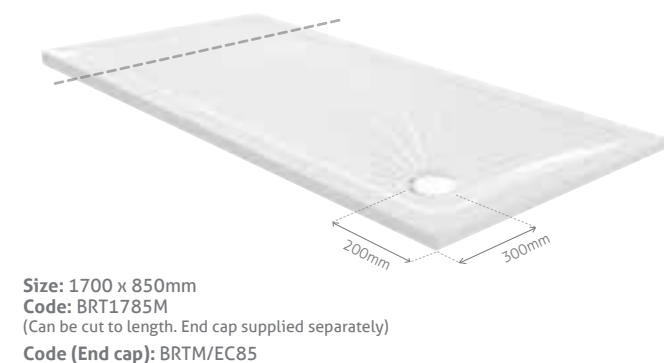
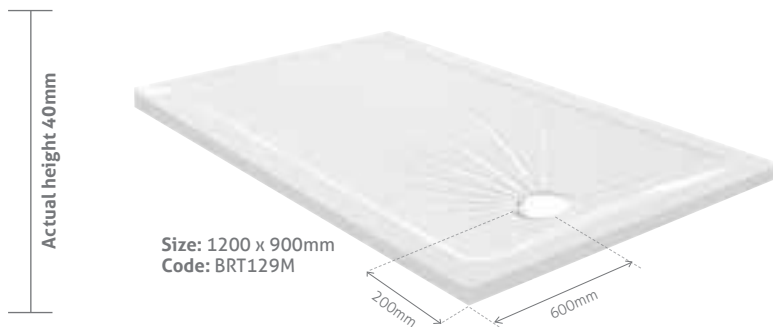

## All Slimline trays come supplied with tiling upstand and waste



All supplied with 90mm trap.  
Code: IMOR/HKIT  
Alternatives available, see Page 40



### Self-Adhesive Tiling Upstand

Supplied with high performance tile upstand waterproofing membrane, providing a guaranteed seamless link between tray and tile

Waterproof Self Adhesive Tiling Upstand (3.5m roll - 120mm wide)

Code: US12350

See Floor and Door Options on Pages 52 - 55 for a bath replacement tray

\*DIN 51097:1992 Determination of anti-slip properties; wet loaded barefoot areas; walking method; ramp test.

## Drain options available for showering solutions

Drainage is supplied as standard with all Impey floor formers and shower trays. If an alternative is required, we provide solutions for various wetroom spaces and to overcome any limitations. In some situations, a certain drain type will be required due to the existing flooring it is placed in. We offer a range of Gravity, Pumped and Slimline options.

### Universal Trap for wetrooms

With grey cover Code: UTVG01/H

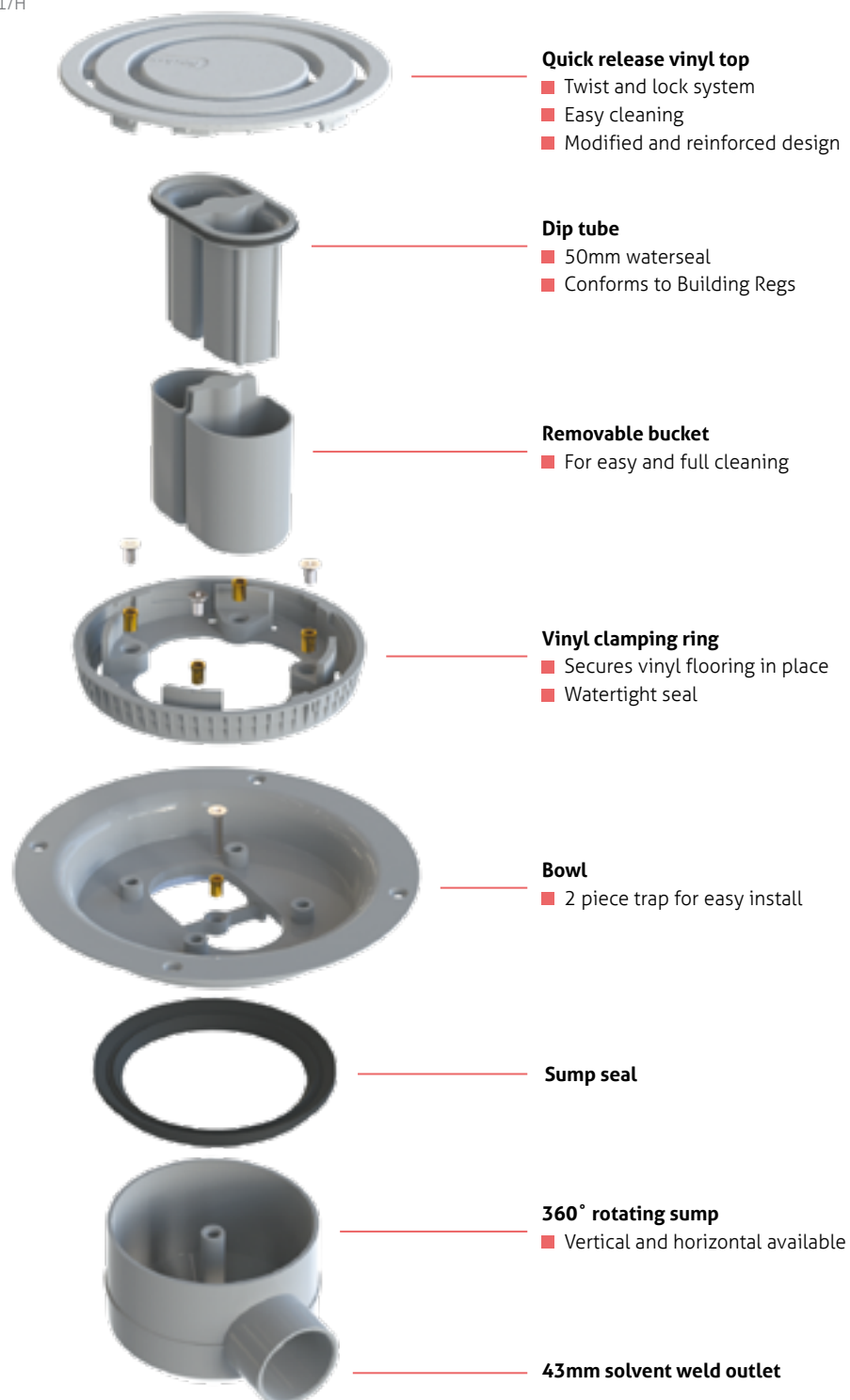

Made in the UK.  
See Pages 4 - 7

# Drainage options for vinyl wetroom floors

All Level-Dec EasyFit and Level-Grade floor formers are supplied with our gravity Horizontal and Vertical outlet, Slimline traps or Pumped gully. Alternative options are available at extra cost. Please specify when ordering.

## Horizontal outlet (supplied as standard)

With grey cover Code: UTVG01/H  
With chrome cover Code: UTVCO1/H (CHROME)



## Vertical outlet

With grey cover and clamping ring Code: UTVG01/V  
With chrome cover and clamping ring Code: UTVCO1/V (CHROME)



## Slim+ waste

A waterless trap with a removable one way silicone seal  
Slim+ waste Vertical Grey Code: SLW2VG/H  
Slim+ waste Vertical Chrome Plastic Code: SLW2VCP/H  
Additional charges apply

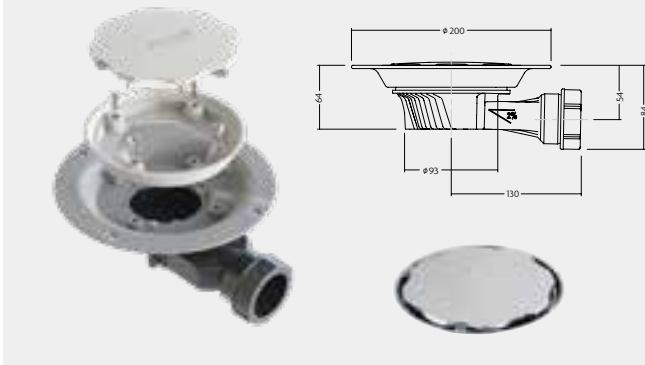

## For pumped waste

With grey cover and clamping ring Code: TAD13  
With chrome cover and clamping ring Code: TAD3/CP  
Additional charges apply

Available with either grey or chrome cover and clamping ring

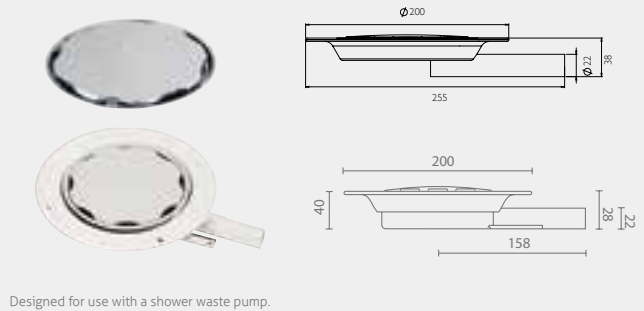

## Horizontal outlet

75mm waterseal with a 50mm outlet and a 40mm reducer  
Code: TSG1WH  
Additional charges apply



## Vertical outlet

75mm waterseal with a 110mm outlet and a 50mm reducer  
Code: TSG2  
Additional charges apply



## Drainage options for shower trays

Shower trays that require a gravity waste are supplied as standard with an IMOR/HKIT. Alternatively we can offer other waste outlet types which you can specify when ordering.

### Horizontal outlet (supplied as standard)

50mm water seal with a 43mm swivel joint outlet  
Code: IMOR/HKIT

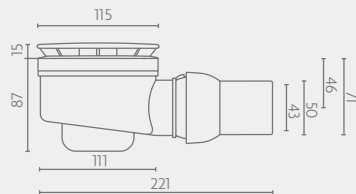

### Vertical outlet

50mm water seal  
Code: IMOR/VKIT

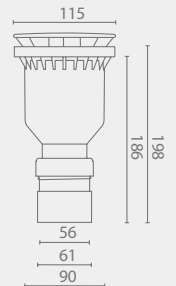

### For pumped waste

Code: IMOR/PKIT

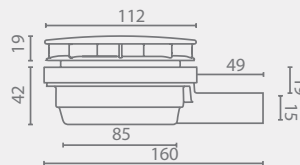

### Slim+ waste

A waterless trap with a removable one way rubber seal  
Code: SLW2STCP/H

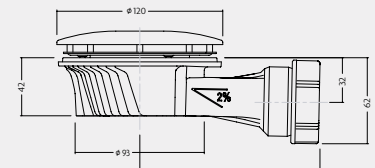

## Impey Bath Adapter for Lifetime Home

The Impey Bath Adapter allows you to install a wetroom floor, with a bath above to meet the needs of tenants today, whilst allowing for a simple and economical conversion to a level-access wetroom, to suit future requirements.



Bath Adapter  
Compatible with: UTVG01/H

Code: UT/BC

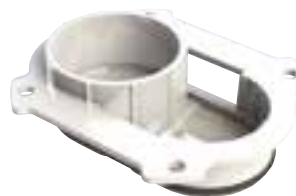

For advice and support on any of our products, call our Technical team on 01460 256080 or visit [www.impeyshowers.com](http://www.impeyshowers.com)

## The Design: Radiate Trays with Pumped Drain

Developed by our Research & Development team, our range of Radiate trays provide an advanced ultra-quiet pumped solution for unbreachable floors.

The decision of the 40mm tray means all pipework is situated within the depth of the tray and has been designed to allow the pipework to exit from any side. This ensures the depth needed to install this shower tray and pumped system never needs to exceed the height of the 40mm tray and therefore eliminates the need to work into the flooring. This makes it ideal for high rise developments.

Designed to work with Whale Switch Connect, Direct Connect and Instant Match waste pumps.

Further details on Pumped drainage options on Pages 80 - 83

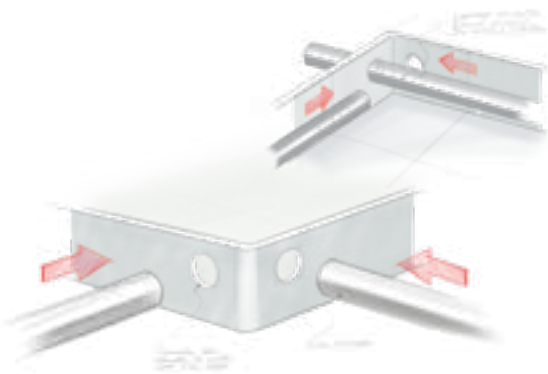

## How it works

Due to the gradient and channeled design of the Radiate tray, the water naturally flows down the drain where it falls into a specially designed chamber. With strategically positioned sections, the water then circulates through the two outer paths towards the pumped outlet.

The mouth of the outlet is only 15mm high to ensure it is filled with water when in use, this then minimises the amount of air being drawn into the pump. This innovative design heavily reduces the noise which can incur with standard pumped waste options.

The pump is angled to draw the water in as well as up to the pipework, which is situated higher than the initial chamber. By doing this it avoids any pipework having to be situated below and therefore eliminating the need to recess into the flooring.

More information on Radiate Trays and available sizes on Pages 20 - 23

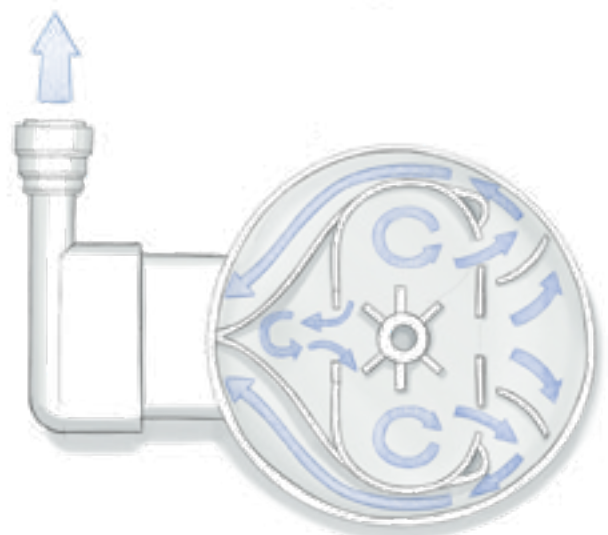
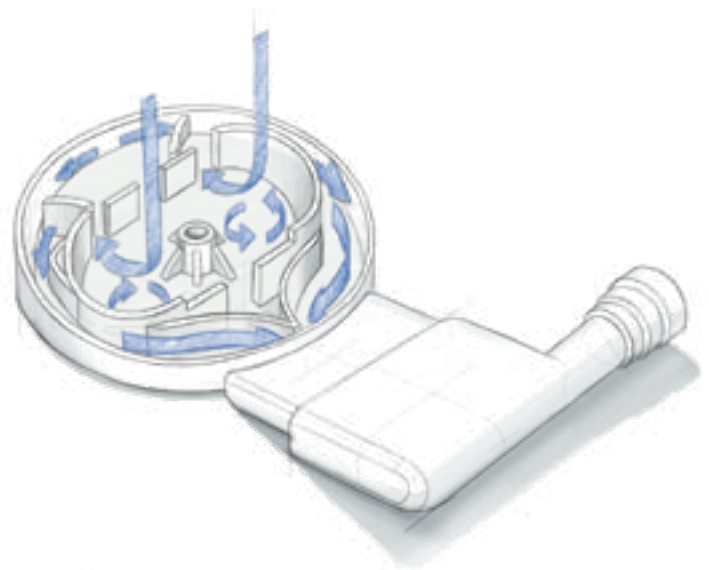



# Shower Doors, Panels, Curtains and Screens

## A range of options to suit every situation

Our portfolio of Half Height Shower Doors, Bi-Fold Doors, Glass Panels, Curtains and Carer Screens products ensure we can provide with numerous installations in a wetroom and bathroom environment.

### Elevate Half Height Doors

Pages 46 - 47



Elevate and FreeGlide Half Height Doors are available as Bi-Fold and Sliding options.

### FreeGlide Half Height Doors

Pages 48 - 49



**NEW**



## Double Bi-Fold Doors with Coving Profile

Pages 50 - 51

With the addition of our new Coving Profiles, the doors can be installed onto a vinyl floor without a threshold.

The door design makes this the perfect door design when maximum space is advantageous.



Double Bi-Fold Doors can be installed in a corner or an alcove.



Supreme Glass Panel  
Pages 52 - 55



Curtain Rails and Shower Curtains  
Pages 56 - 57



Freestanding Carer Screens  
Page 57



For advice and support on any of our products, call our Technical team on 01460 256080 or visit [www.impeyshowers.com](http://www.impeyshowers.com)

# Half Height Shower Doors

## Elevate and FreeGlide Designs

### Outstanding solutions for every care sector installation

Impey's Half Height Shower Doors set the industry benchmark since 1990 and now they're an even smarter choice to specify.

Designed, developed and manufactured by Impey in the UK, these ranges provide outstanding innovative features for both user and carer and those in the care sector - from Occupational Therapists specifying for private and sheltered homes to Technical Officers looking for quality and affordability when pricing for care homes and new builds.

There is no better Half Height Shower Door.



Lifetime Guarantee  
details on Page 94



Made in the UK.  
See Pages 4 - 7

### Specifier Benefits

- Available in wide range of options and sizes
- Easy to replace seal and serviceable parts
- Designed and built by Impey
- Special and bespoke sizes available to order
- Unbeatable customer service and technical support
- Door height setting tool supplied as standard to ensure correct clearance for door seals
- Easy fitting - using TigerFix to anchor at the base so there is no drilling required through the vinyl floor or shower tray
- Flexible adjustment for ease of installation
- Average install time of 20 minutes
- Lifetime guarantee

### Why choose Impey?

- Designed and manufactured to the highest standards for safety and durability
- Special and bespoke sizes available in both Elevate and FreeGlide
- Solutions to suit every healthcare installation, improving the lives of thousands of people every year
- Impey provide everything you need for a high quality wetroom Installation
- Unbeatable customer service offering order processing and technical support, plus installation training
- Made in the UK



All Elevate and FreeGlide Half Height Doors are designed and manufactured to fit a wetroom, a shower tray or a bath replacement tray. Please follow the guide to help assess the placement of the Half Height Doors.

## Half Height Door - handing

When working out whether the area needs a Left Handed or a Right Handed Half Height Door, it is best to refer to the roomset diagram.

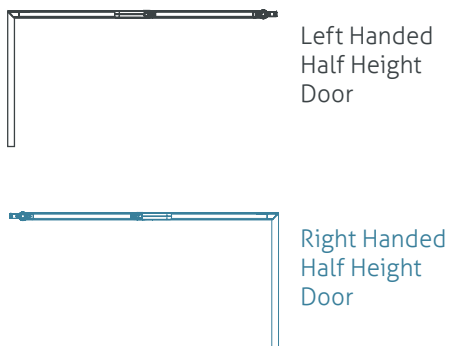

Roomset diagram

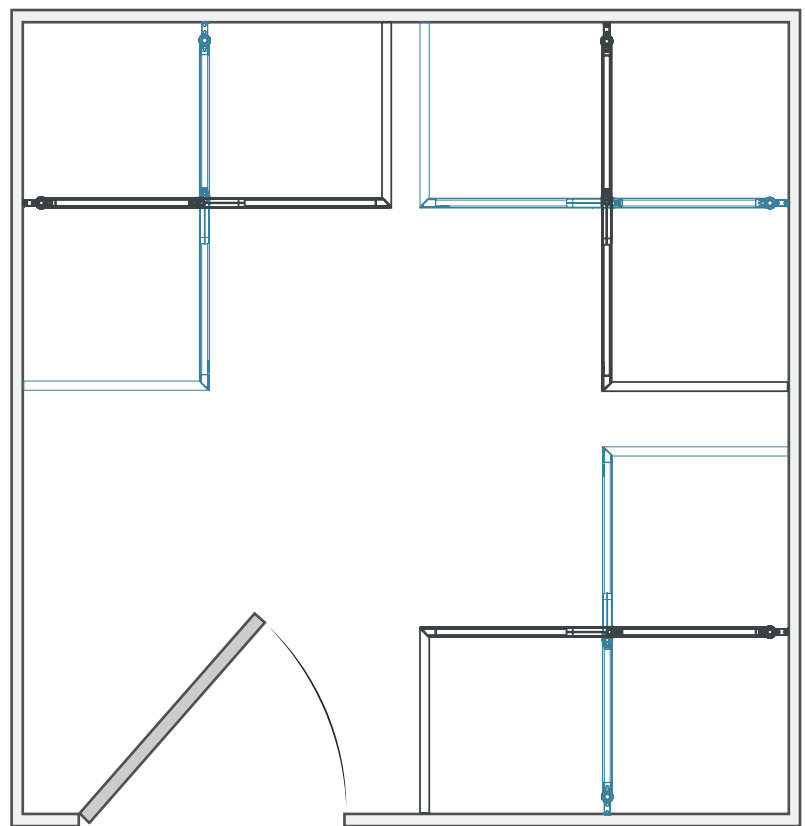

## Half Height Door - sizing

### Standard

Half Height Doors are manufactured to allow for wall tile, or shower board finishes as standard. Do not make extra deductions for wall finishes when taking measurements.

### Special / Bespoke

If the dimensions provided upon ordering are 'Tile-to-Tile', 10mm is added per door to ensure maximum size ordered.

## Half Height Door - measuring

Elevate and FreeGlide have been designed to feature a 25mm downward compensation to make allowance for untrue walls.

Please check all measurements prior to ordering, and contact our Technical Team if you have any queries.

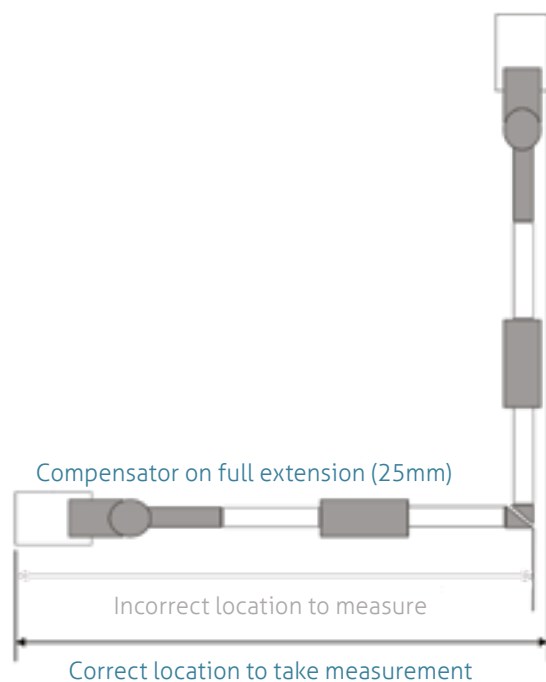

For advice and support on any of our products, call our Technical team on 01460 256080 or visit [www.impeyshowers.com](http://www.impeyshowers.com)

# Half Height Shower Doors

## Elevate

Intuitive and easy lifting door design

**UK CA** **CE** CE tested to BS EN 14428

### Easy to grasp latch handle

No grip required for users with limited strength or mobility by simply placing your hand through and lifting

### Colour contrasting design

To assist users who are partially sighted

Elevate Bi-Fold Shower Door

### Elevate paddle

Simply rotate the paddle 90° to lift the doors clear of the floor

### Anti-glare safety glazing

Considered anti-glare surfaces for users with dementia

### PETG safety panels

Shatterproof panels as standard

### Easy clean design

Doors are designed with concealed moving parts and screw heads to minimise areas where dirt can build up

### Internal glazing seals

Eliminate dirt traps and provides a stay clean longer finish

### Versatile wall channel

Door comes with two wall channel molds for vinyl wetroom or shower tray

### Double contact floor seals

To minimise water leaks

### Enclosed hinges

To eliminate dirt and finger traps

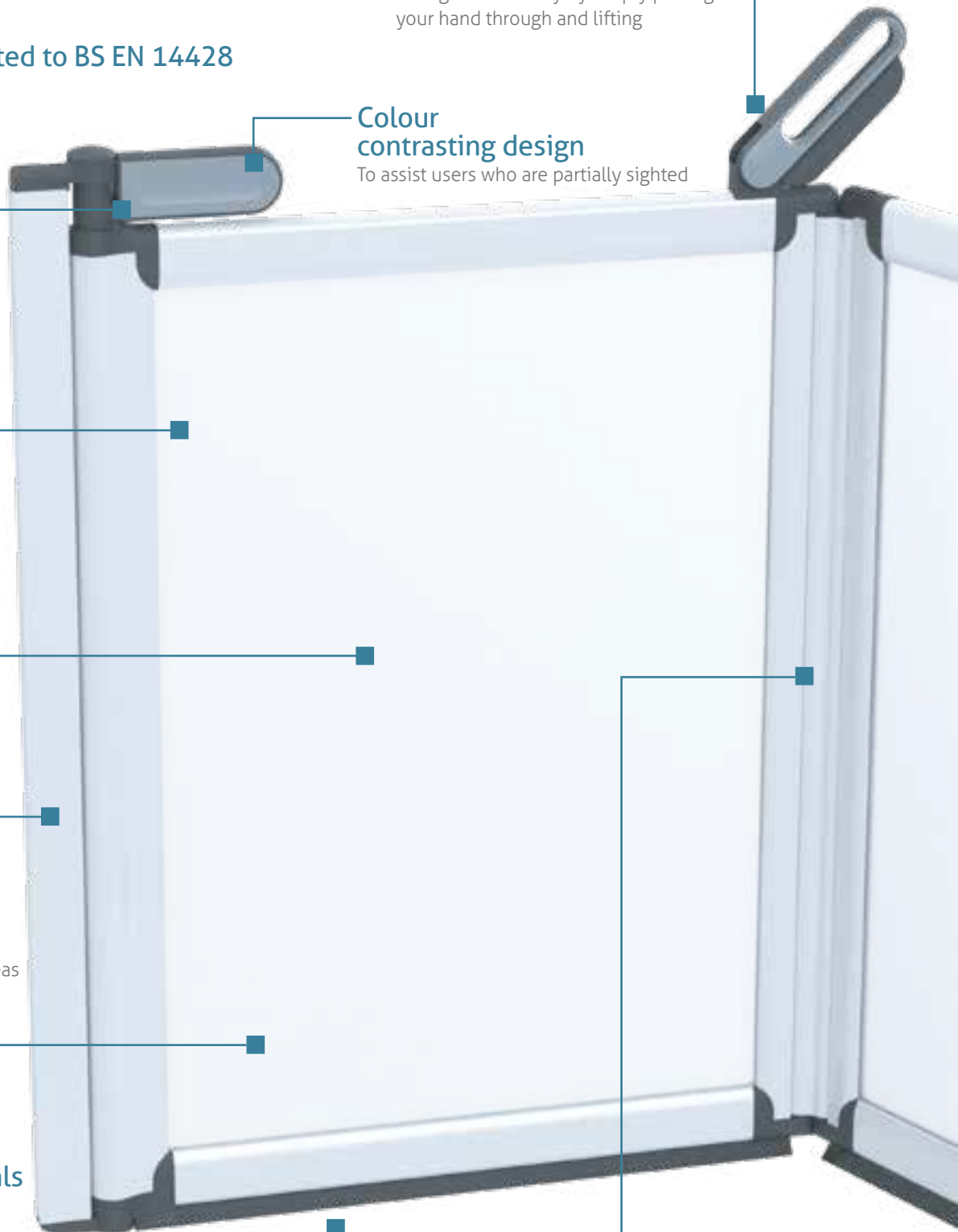



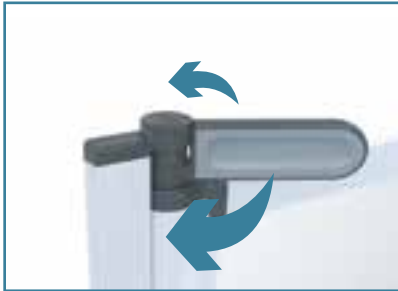

Paddle rotates 90° to lift the doors clear of the floor



Bi-Fold Door only

Latch handle lifts up and down to lock doors into place



Bi-Fold Door only

Bi-Fold Doors can be folded back to allow for wider opening and storage

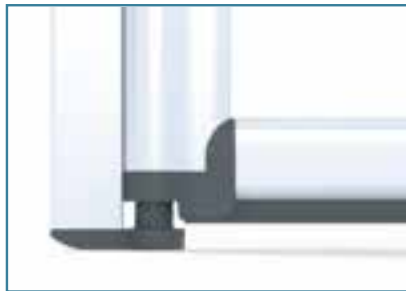

When the door is opened, the Elevate door rises to create a 15mm gap. This is from the bottom of the seal to the top of the shower tray or vinyl floor

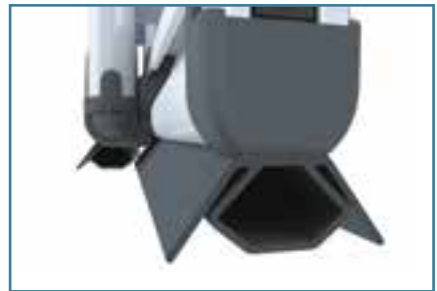

Double contact seals minimises water leaks



Elevate doors can be installed on vinyl or onto a shower tray due to the versatile wall channel. See Floor and Door Options on Pages 88 - 93



For vinyl wetroom install



For shower tray install



Elevate Sliding Shower Door



View Elevate Half Height Doors video



Lifetime Guarantee details on Page 94



Made in the UK. See Pages 4 - 7

# Half Height Shower Doors

## FreeGlide

Assured quality and advanced design features from the industry's leading brand

**UK CA** **CE** CE tested to BS EN 14428

FreeGlide Sliding Shower Door

### Easy clean

Simple unclip feature for thorough cleaning. Doors are designed with concealed moving parts and screw heads to minimise areas where dirt can build up

### Easy to use

No grip required for users with limited strength and mobility by simply placing your hand through and sliding

### Easy action

Easy to use FreeGlide rising hinge

### Versatile wall channel

Door comes with two wall channel molds for vinyl wetroom or shower tray

### Enclosed hinges

To eliminate dirt and finger traps

### Shatterproof PETG panels as standard

### Double contact floor seals

To minimise water leaks

### Easy on the eye

Considered anti-glare surfaces for users with dementia

FreeGlide Bi-Fold Shower Door



Bi-Fold Doors can be folded back to allow for wider opening and storage

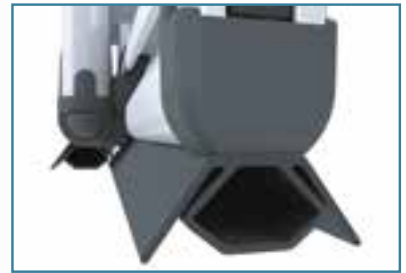

Double contact seals minimises water leaks



Unique sliding door unclip pivot mechanism - no tools required



No grip required for users with limited strength and mobility by simply placing your hand through

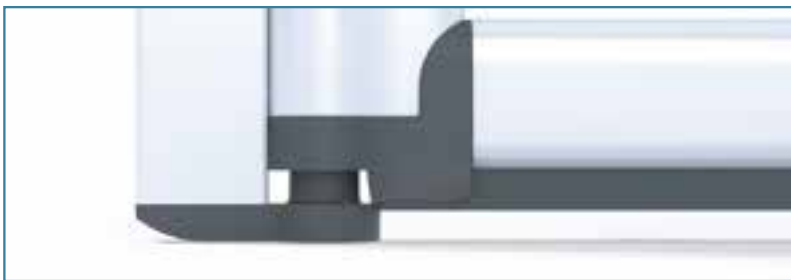

10mm When the door is opened, the FreeGlide design allows for a 10mm gap at the bottom. This is from the bottom of the seal to the top of the shower tray or vinyl floor



View FreeGlide Half Height Doors video

FreeGlide doors can be installed on vinyl or onto a shower tray due to the versatile wall channel. See Floor and Door Options on Pages 88 - 93



For vinyl wetroom install



For shower tray install



Lifetime Guarantee details on Page 94



Made in the UK. See Pages 4 - 7

# Floor and Door Options

## Wetroom floor Corner

All corner options can be supplied with L-shaped curtain rail and curtain. All door configurations are available left or right handed (left hand illustrated).

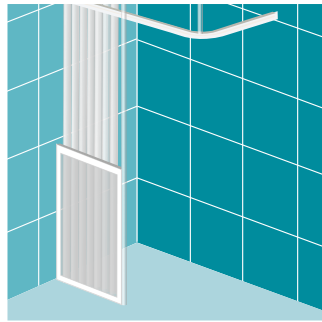

**Option C**

Fixed 750mm wide half height fixed panel, floor to ceiling pole

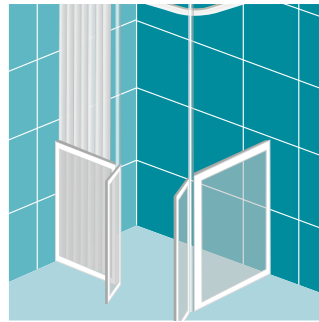

**Option D**

Two fixed half height panels, one 400mm on front, with floor to ceiling poles with one door hung from each panel

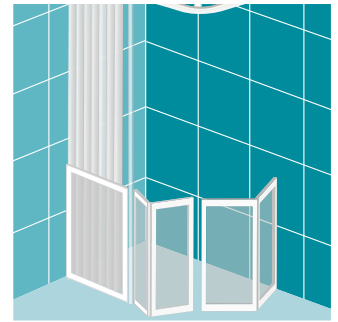

**Option E**

400mm fixed half height panel with floor to ceiling pole and a pair of bi-fold doors meeting on corner



Floor Former  
Level-Dec EasyFit

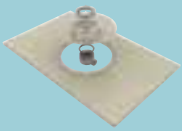

TRAY SIZE

800 x 800

900 x 900

1000 x 1000

1200 x 750

1200 x 900

1200 x 1200

1300 x 800

1400 x 900

1500 x 800

1500 x 1200

1700 x 750\*

1850 x 900\*



For door options with Level-Grade please call our Technical team on 01460 256080

## Wetroom floor Alcove

All alcove options can be supplied with L-shaped curtain rail and curtain. All door configurations are available left or right handed (left hand illustrated).

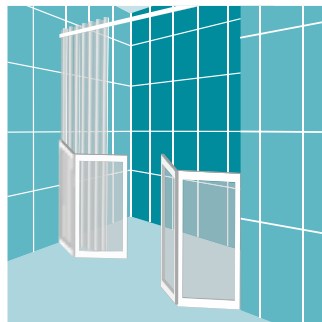

**Option G**

Two half bi-fold doors meeting in the middle

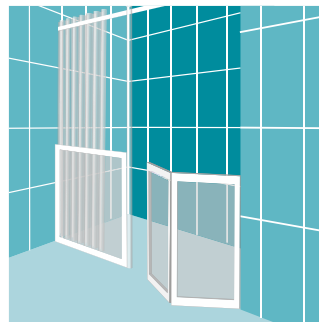
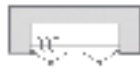

**Option M**

One bi-fold door meeting fixed 400mm panel with floor to ceiling pole

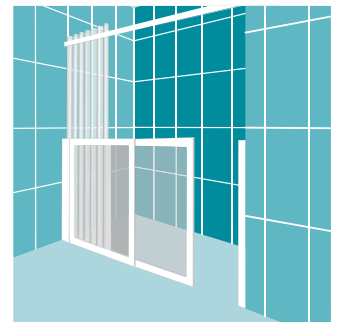

**Option 2**

One set of sliding doors hung off one side latching on opposite wall



Floor Former  
Level-Dec EasyFit



TRAY SIZE

800 x 800

900 x 900

1000 x 1000

1200 x 750

1200 x 900

1200 x 1200

1300 x 800

1400 x 900

1500 x 800

1500 x 1200

1700 x 750\*

1850 x 900\*



\*Door options for Mendip Bath Replacement Tray, Radiate Bath Replacement Tray, Mantis Bath Replacement Tray, Level-Dec EasyFit 1700x750 and 1850x900 cut to length, SL3517075 and MEN701 are only suitable if they are fitted full size (not trimmed to length)





# Floor and Door Options

## Shower Tray

### Corner

All corner options can be supplied with L-shaped curtain rail and curtain. All door configurations are available left or right handed (left hand illustrated).

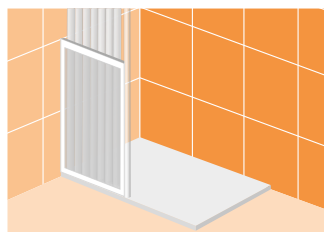



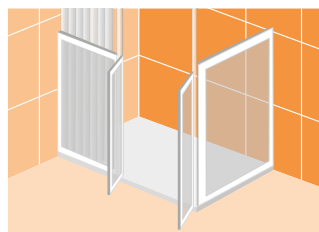

**Option C**  
Fixed 750mm wide half height fixed panel, floor to ceiling pole

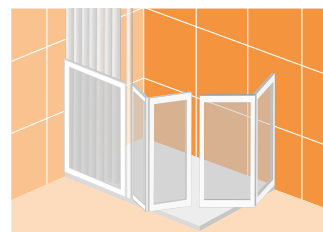

**Option D**  
Two fixed half height panels, one 400mm on front, with floor to ceiling poles with one door hung from each panel



**Option E**  
400mm fixed half height panel with floor to ceiling pole and a pair of bi-fold doors meeting on corner

Shower Tray	CODE	TRAY SIZE			
Slimline 	SL358080	800 x 800	●		
	SL359090	900 x 900	●		
	SL35100100	1000 x 1000	●		
	SL3512075	1200 x 750	●	●	●
	SL3512090	1200 x 900	●	●	●
	SL3513070	1300 x 700	●	●	●
	SL3513075	1300 x 750	●	●	●
	SL3515075	1500 x 750	●	●	●
	SL3517075*	1700 x 750	●	●	●
Slimline Bath	BRT129M	1200 x 900	●	●	●
Replacement Tray	BRT1775M	1700 x 750	●	●	●
	BRT1785M	1700 x 850	●	●	●
Mendip 	MEN501	900 x 900	●		
	MEN601	1000 x 1000	●		
	MEN101	1250 x 710	●	●	●
	MEN201	1250 x 830	●	●	●
	MEN301	1500 x 710	●	●	●
	MEN401	1500 x 830	●	●	●
	MEN701*	1850 x 710	●	●	●
Radiate 	RDT9090/P	900 x 900	●		
	RDT100100/P	1000 x 1000	●		
	RDT12070/P	1200 x 700	●	●	●
	RDT12080/P	1200 x 800	●	●	●
	RDT12090/P	1200 x 900	●	●	●
	RDT13070/P	1300 x 700	●	●	●
	RDT13080/P	1300 x 800	●	●	●
	RDT14070/P	1400 x 700	●	●	●
	RDT14080/P	1400 x 800	●	●	●
	RDT14090/P	1400 x 900	●	●	●
	RDT15070/P	1500 x 700	●	●	●
	RDT15080/P	1500 x 800	●	●	●
	RDT17070/P	1700 x 700	●	●	●
RDT17080/P	1700 x 800	●	●	●	
Mantis 	MTS9090	900 x 900	●		
	MTS100100	1000 x 1000	●		
	MTS12070	1200 x 700	●	●	●
	MTS12080	1200 x 800	●	●	●
	MTS13070	1300 x 700	●	●	●
	MTS13080	1300 x 800	●	●	●
	MTS14070	1400 x 700	●	●	●
	MTS14080	1400 x 800	●	●	●
	MTS15070	1500 x 700	●	●	●
	MTS15080	1500 x 800	●	●	●
	MTS17070	1700 x 700	●	●	●
	MTS17080	1700 x 800	●	●	●

\*Door options for Mendip Bath Replacement Tray, Radiate Bath Replacement Tray, Mantis Bath Replacement Tray, Level-Dec EasyFit 1700x750 and 1850x900 cut to length, SL3517075 and MEN701 are only suitable if they are fitted full size (not trimmed to length)



# Floor and Door Options

## Shower Tray

### Alcove

All alcove options can be supplied with straight curtain rail and curtain. All door configurations are available left or right handed (left hand illustrated).

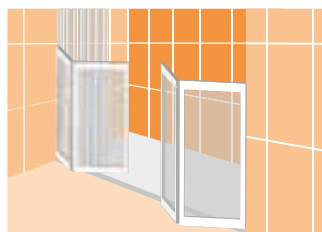

**Option G**

Two half bi-fold doors meeting in the middle

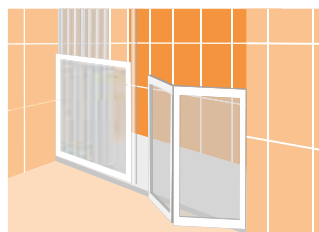

**Option M**



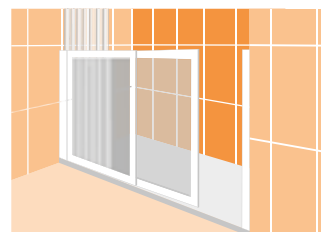

One bi-fold meeting fixed 400mm panel with floor to ceiling pole



**Option 2**

One set of sliding doors hung off one side latching on opposite wall



Shower Tray	CODE	TRAY SIZE			
Slimline 	SL358080	800 x 800			•
	SL359090	900 x 900			•
	SL35100100	1000 x 1000			•
	SL3512075	1200 x 750	•	•	•
	SL3512090	1200 x 900	•	•	•
	SL3513070	1300 x 700	•	•	•
	SL3513075	1300 x 750	•	•	•
	SL3515075	1500 x 750	•	•	•
SL3517075*	1700 x 750	•	•		
Slimline Bath Replacement Tray	BRT129M	1200 x 900	•	•	•
	BRT1775M	1700 x 750	•	•	
	BRT1785M	1700 x 850	•	•	
Mendip 	MEN501	900 x 900			•
	MEN601	1000 x 1000			•
	MEN101	1250 x 710	•	•	•
	MEN201	1250 x 830	•	•	•
	MEN301	1500 x 710	•	•	•
	MEN401	1500 x 830	•	•	•
	MEN701*	1850 x 710	•	•	
Radiate 	RDT9090/P	900 x 900			•
	RDT100100/P	1000 x 1000			•
	RDT12070/P	1200 x 700	•	•	•
	RDT12080/P	1200 x 800	•	•	•
	RDT12090/P	1200 x 900	•	•	•
	RDT13070/P	1300 x 700	•	•	•
	RDT13080/P	1300 x 800	•	•	•
	RDT14070/P	1400 x 700	•	•	•
	RDT14080/P	1400 x 800	•	•	•
	RDT14090/P	1400 x 900	•	•	•
	RDT15070/P	1500 x 700	•	•	•
	RDT15080/P	1500 x 800	•	•	•
	RDT17070/P	1700 x 700	•	•	
RDT17080/P	1700 x 800	•	•		
Mantis 	MTS9090	900 x 900			•
	MTS100100	1000 x 1000		•	•
	MTS12070	1200 x 700	•	•	•
	MTS12080	1200 x 800	•	•	•
	MTS13070	1300 x 700	•	•	•
	MTS13080	1300 x 800	•	•	•
	MTS14070	1400 x 700	•	•	•
	MTS14080	1400 x 800	•	•	•
	MTS15070	1500 x 700	•	•	•
	MTS15080	1500 x 800	•	•	•
	MTS17070	1700 x 700	•	•	
	MTS17080	1700 x 800	•	•	



# Shower Doors

## Double Bi-Fold Doors

Create a high-end looking vinyl bathroom for level-access showering

The Double Bi-Fold Doors are the ultimate solution where space, safety and access are restricted, but aesthetics still count.



With the addition of our new Coving Profiles, the doors can be installed onto a vinyl floor without a threshold.

The bi-folding design allows both doors to be folded back to the wall to give a large opening, making it extremely practical for wheelchair use. This design makes it the perfect door when maximum space is advantageous.

### Features & Benefits

- Minimal frameless design, 2000mm high
- Doors can be installed onto vinyl flooring for level-access showering
- Easy to fit – no fixing to the floor
- Vinyl continues seamlessly up the wall – guaranteed waterproofing
- Easy to use – soft, effortless folding doors
- Warmer showering environment – surrounded by enclosure
- Concealed fixing & seamless profiles – aesthetically pleasing
- Easy to clean – 'Stay clean glass', removable seals, concealed fixings & seamless profiles (no dirt traps)
- Space-saving – rising hinge mechanism, set at 90° allowing doors to be folded back to the wall
- Toughened safety glass – BS EN 12150 and BS EN 12600 standard
- Soft-touch handle – acts as bump stop and good grip for user
- CE certified and compliant to BS EN 14428
- Profile and hinges pivot 180° – extremely versatile
- Soft, ultra-clear seals
- Versatile doors - can be installed in a corner or alcove



- Doors come pre-assembled – for easy install
- Door profiles have pre-drilled holes
- 20mm screwless adjustment per profile
- Coving Profiles are pre-cut
- In-house Technical Team to support



Product sizes & codes	Width (mm)	Height (mm)	Pack size	Product code
Double Bi-Fold Door	760	2000	1	P8CB76CUC
Double Bi-Fold Door	800	2000	1	P8CB80CUC
Double Bi-Fold Door	900	2000	1	P8CB90CUC
Double Bi-Fold Door	1000	2000	1	P8CB10CUC
Coving Profile	30	2000	1	P8CBICEPC



Corner installation on vinyl	Overall size (mm)	Height (mm)	Adjustment range width (mm)	Adjustment per end (mm)
Double Bi-Fold Door (760) + Coving Profile x 2	760 x 760	2000	765 - 785	20
Double Bi-Fold Door (800) + Coving Profile x 2	800 x 800	2000	805 - 825	20
Double Bi-Fold Door (900) + Coving Profile x 2	900 x 900	2000	905 - 925	20
Double Bi-Fold Door (1000) + Coving Profile x 2	1000 x 1000	2000	1005 - 1025	20

Alcove installation on vinyl	Overall size (mm)	Height (mm)	Adjustment range width (mm)	Adjustment per end (mm)
Double Bi-Fold Door (760) + Coving Profile x 2	1500	2000	1500 - 1540	20
Double Bi-Fold Door (800) + Coving Profile x 2	1600	2000	1580 - 1620	20
Double Bi-Fold Door (900) + Coving Profile x 2	1800	2000	1780 - 1820	20
Double Bi-Fold Door (1000) + Coving Profile x 2	2000	2000	1980 - 2020	20

# Glass Panels

## Supreme Glass Shower Panels

Luxury combined with practicality

Supreme Glass Shower Panels offer a luxurious appearance, whilst also providing practical support and ease of entry to the shower, fitted on either a wetroom floor or shower tray.

They are supported by a polished aluminium column, which can be ceiling fixed, or wall braced, which offers the option of hanging a shower curtain to provide further screening. The column is secured to the floor with TigerFix, an innovative new fitting that requires no screws and can also be easily removed.

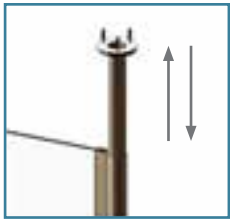

### Telescopic pole

Simply adjust to height, twist, lock & secure. No screws or cutting required



### Coving profile

For areas where a covered vinyl floor has been installed you will need to order a coving extension profile

**Code:** ICEP2000



### TigerFix

An innovative adhesive solution that allows easy install without the need for drilling or fixing. It can also be easily removed without causing any damage

### Telescopic pole

Can also be attached by wall braced fixing

### 2000mm high, plain glass with Aqua-Shield Easy Clean Finish

### Rigid strong support

### 8mm toughened safety glass

### Shower Panels are available in 5 sizes

700MM, 800MM, 900MM, 1000MM AND 1200MM WIDE

### Coving profile

### TigerFix





## Benefits

- Available in 5 sizes
- Two install options
- Lifetime Guarantee
- CE compliant to BS EN 14428
- Coving extension profile available for vinyl floors
- No breaching of the floor required to fix the pole, protects against water ingress
- Pre-drilled wall profile
- Push in glass profile with 20mm adjustment
- Coving extension profile available
- Secured with innovative TigerFix, so no drilling required to secure pole to floor
- Suitable for use on shower tray or level-access wetroom floor
- All fixings and seals provided
- Fully detailed instructions supplied
- Unbeatable customer service



Lifetime Guarantee  
details on Page 94

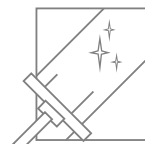

Aqua-Shield  
Easy Clean Finish



# Glass Panels

## Supreme Glass Shower Panels

### Floor to ceiling with plain glass

ISS70CUC.	700MM WIDE
ISS80CUC.	800MM WIDE
ISS90CUC.	900MM WIDE
ISS10CUC.	1000MM WIDE
ISS12CUC.	1200MM WIDE

Please note: For areas where a covered vinyl floor has been installed you will need to order a coving extension profile

Code: ICEP2000



Lifetime Guarantee  
details on Page 94

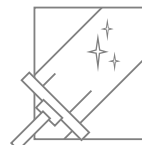

Aqua-Shield  
Easy Clean Finish

UK  
CA CE



### Wall braced with plain glass

ISSW70CUC.	700MM WIDE
ISSW80CUC.	800MM WIDE
ISSW90CUC.	900MM WIDE
ISSW10CUC.	1000MM WIDE
ISSW12CUC.	1200MM WIDE

Please note: For areas where a covered vinyl floor has been installed you will need to order a coving extension profile

**Code:** ICEP2000

Shower curtain unavailable for purchase



Lifetime Guarantee details on Page 94



Aqua-Shield Easy Clean Finish





# Curtain Rails, Shower Curtains and Screens

## Curtain Rails

All the rails are white and made from powder coated aluminium and come complete with fixings which includes, all brackets, screws, rawl plugs, ceiling support rods and shower curtain hooks and gliders.

Bespoke sizes can be made to order.



Made in the UK.  
See Pages 4 - 7

### Product codes & sizes

#### Curved Rails

SRL-9090W	CURVED RAIL 900 x 900 + FIXING KIT WHITE
SRL-120120W	CURVED RAIL 1200 x 1200 + FIXING KIT WHITE
SRL-13090W	CURVED RAIL 1300 x 900 + FIXING KIT WHITE
SRL-15090W	CURVED RAIL 1500 x 900 + FIXING KIT WHITE
SRL-150120W	CURVED RAIL 1500 x 1200 + FIXING KIT WHITE
SRL-18090W	CURVED RAIL 1800 x 900 + FIXING KIT WHITE



#### Standalone U Rails

These are to be used when not paired with a half height door. All are provided with white fixing kits as standard.

SRUT-9090W	(W)900 x (D)900 STANDALONE U-RAIL
SRUT-100100W	(W) 1000 x (D)1000 STANDALONE U-RAIL
SRUT-120120W	(W) 1200 x (D)1200 STANDALONE U-RAIL
SRUT-13080W	(W) 1300 x (D)800 STANDALONE U-RAIL
SRUT-150120W	(W) 1500 x (D)1200 STANDALONE U-RAIL

#### Straight Rails

SRS-130W	STRAIGHT SHOWER RAIL 1.3M + FIXING KIT WHITE
SRS-200W	STRAIGHT SHOWER RAIL 2M + FIXING KIT WHITE
SRS-250W	STRAIGHT SHOWER RAIL 2.5M + FIXING KIT WHITE



#### Curved Rail Support Rod

The 1.2m trimmable curtain support rod is for installations with high ceilings.

SR-CRSW	CURVED RAIL SUPPORT ROD 1.2m + FIXING KIT WHITE
---------	---



#### U Rails

To be purchased when used in combination with a half height door.

SRU-100100W	U RAIL 1000 x 1000 + FIXING KIT WHITE (W)900mm x (D)950mm
SRU-120120W	U RAIL 1100 x 1150 + FIXING KIT WHITE (W)1092mm x (D)1140mm
SRU-13080W	U RAIL 1300 x 800 + FIXING KIT WHITE (W)1200mm x (D)750mm
SRU-14090W	U RAIL 1400 x 900 + FIXING KIT WHITE (W)1300mm x (D)850mm
SRU-150120W	U RAIL 1500 x 1200 + FIXING KIT WHITE (W)1400mm x (D)1150mm



#### Spare Hooks and Gliders

Spare Curtain rail hooks and gliders for curtain attachment.  
SR-HGK SPARE HOOKS & GLIDERS

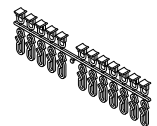

## Shower Curtains

- White only 100% Polyester
- CIBA antibacterial & fungal protection
- Easy care fabric, specially produced for the bathroom
- Machine washable
- Weighted hem to ensure good contact with tray or wet floor
- Range of sizes to suit all showering options



Code	No. of rings	Width x Drop
IC1212	8 eyes	(W)1200 x (D)1200mm
IC181250	12 eyes	(W)1800 x (D)1250mm
IC1818	12 eyes	(W)1800 x (D)1800mm
IC1820	12 eyes	(W)1800 x (D)2000mm
IC1824	12 eyes	(W)1800 x (D)2400mm
IC2018	14 eyes	(W)2000 x (D)1800mm
IC2020	14 eyes	(W)2000 x (D)2000mm
IC2022	14 eyes	(W)2000 x (D)2200mm
IC2121	12 eyes	(W)2100 x (D)2100mm
IC2218	14 eyes	(W)2200 x (D)1800mm
IC2220	14 eyes	(W)2200 x (D)2000mm
IC2222	14 eyes	(W)2200 x (D)2200mm
IC2418	16 eyes	(W)2400 x (D)1800mm
IC2420	16 eyes	(W)2400 x (D)2000mm

# Window Bridging Kit

The window bridging kit provides a simple solution in situations where a window causes an obstruction during curtain rail installations.

This kit can be used inside the window opening, outside the window opening and dog leg around the window opening.

**Pack contains:** 1.3m Rail, 1.2m Curtain, 2 corner brackets, pack of hooks and gliders and 2 wall brackets and fittings.

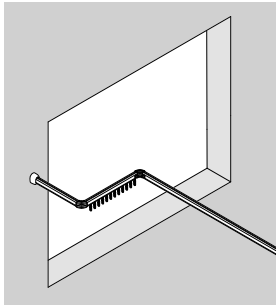

Dog Leg Installation  
Window Bridging Kit

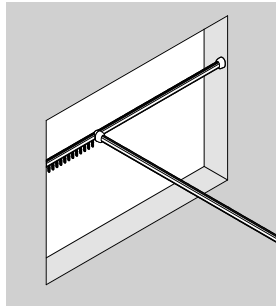

Alcove Window Bridging Kit

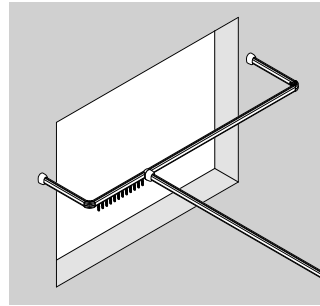

Outer Window Bridging Kit

Product codes & sizes

SR-WBKW WINDOW BRIDGING KIT C/W 1.2 DROP CURTAIN WHITE

# Extension Channel Pack

The Extension Channel Pack is used to increase the width of a door or fixed panel from the wall.

Each extension kit will increase the width by 20mm.

In a corner installation, 2 packs will be necessary and 2 channels can be combined to increase by 40mm.

Each pack contains: 1 wall channel, end cap & fittings.



Product codes & sizes

FG-ECP EXTENSION CHANNEL PACK

# Freestanding Carer Screens

Lightweight portable freestanding shower screens offer an instant solution for shower areas that do not require a permanent fixture. 750mm high and made from white powder coated aluminium with grey handles and flexible floor seals.

All panels are made of semi-transparent and anti-shatter PETG.

Product codes & sizes

FG-IPS1W FREESTANDING SCREEN 2 PANEL 650MM  
FG-IPS2W FREESTANDING SCREEN 2 PANEL 750MM  
FG-IPS3W FREESTANDING SCREEN 2 PANEL 1000MM  
FG-IPS4W FREESTANDING SCREEN 4 PANEL 2 x 400MM wide + 2 x 225MM wide



# Shower Seats





## A variety of wall-mounted and freestanding options

A shower seat is an important addition to a bathroom adaptation. It's a good idea to assess the size and layout of the showering area and the individual needs of the user before deciding upon an option. Also think about: ease of operation; cleaning; transfer from a wheelchair; need for cushioning; whether the seat is warm to the touch; risk of injury; how attractive the seat looks.

### SlimFold range

Pages 60 - 63



### Shower Seats, Chairs and Stools

Pages 64 - 65



For advice and support on any of our products, call our Technical team on 01460 256080 or visit [www.impeyshowers.com](http://www.impeyshowers.com)

# Shower Seats

## SlimFold range

Slim, strong and easy to clean



Lifetime Guarantee  
details on Page 94



Rounded, smooth seats made from flexible polyethylene provide natural padding as well as being comfortable and warm to the touch

Top of the seat is angled back at 4° to allow water to run off the back

No drop down legs eliminating the trip risk for users

- Slim design fits closely to the shower wall
- Seat only protrudes 114mm when folded
- Can support up to 300kg (47 stone)
- Hygienic and easy to clean. Solid surfaces with no dirt traps
- Seat can be mounted as low as 415mm\*
- Mechanism designed to easily fold down and prevents the seat from accidentally dropping down
- High quality corrosion resistant steel

\*427mm for Horseshoe



SlimFold Shower Seat

SlimFold Shower Bench



SlimFold Horseshoe Shower Seat

#### SlimFold Seat range - fold down mechanism

To deploy it you simply pull out the front edge so that the rear of the seat slides down and the arms then fold neatly into place. The top of the seat is angled at 4° so that water runs off the back.

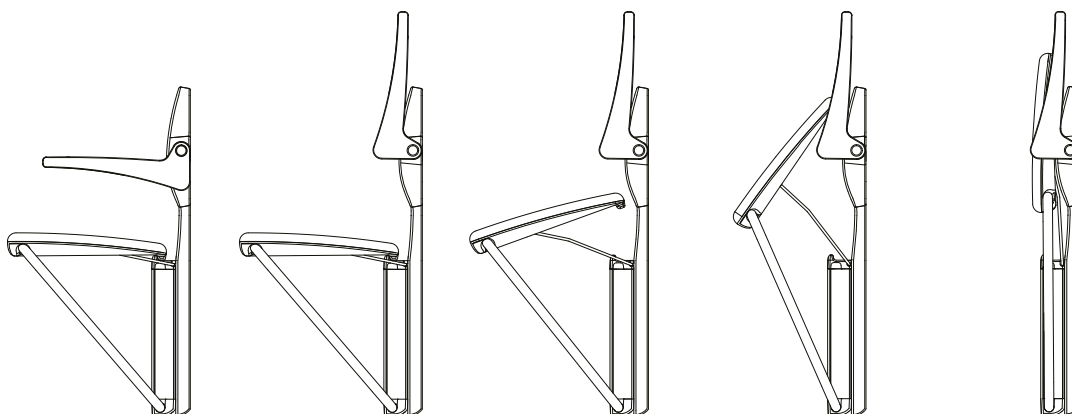



# Shower Seats

## SlimFold Shower Seat

The most stylish, and practical shower seat on the market



The SlimFold Shower Seat is available either as a full seat with a backrest and arms, or as a bench.

Lifetime Guarantee details on Page 94



When folded the seat has a projection of only 114mm, plus you see the stylish top of the seat, rather than the underside. This is also safer, because it cannot accidentally drop down if knocked. To deploy it you simply pull out the front edge so that the rear of the seat slides down and the arms then fold neatly into place.

Using cross bracing wall supports, instead of traditional floor standing legs, prevents the risk of trapping your toes or banging your feet, or of excessive weight on the legs damaging the floor. It also allows you to mount the seat as low as 415mm if required and the top is slightly angled so that water runs off the back.

### SlimFold Shower Seat dimensions



The rounded and smooth seat is comfortable, feels warm to the touch and is easy to use. This revolutionary design, made in Britain using high quality corrosion resistant materials, can support up to 300kg\* (47 stone).



Sky Blue  
Code: SFS250WSB



Grey  
Code: SFS250WGY



White Stone  
Code: SFS250WWS



Sandstone  
Code: SFS250WSS



Black Granite  
Code: SFS250WBG

All SlimFold Shower Seat designs come as standard with White Stone wall fixed back

\*Independently tested to BS12182 and BS12727.  
Patent number: GB: 2497432, US: 9101207  
†Fixings not included

# SlimFold Shower Bench



Lifetime Guarantee details on Page 94

The SlimFold Shower Bench possesses all the features of the SlimFold Shower Seat in terms of colour choice, weight limit and seat folding mechanism. However due to the lack of back and arms it protrudes only 63mm from the wall when folded.

## SlimFold Shower Bench dimensions

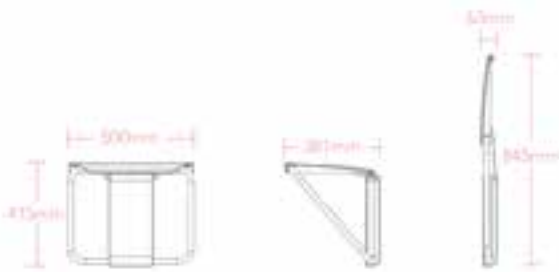

Sky Blue  
Code: SFB250WSB



Grey  
Code: SFB250WGY



White Stone  
Code: SFB250WWS



Sandstone  
Code: SFB250WSS



All SlimFold Shower Bench designs come as standard with White Stone wall fixed back

Black Granite  
Code: SFB250WBG

# SlimFold Horseshoe Shower Seat



Lifetime Guarantee details on Page 94

The SlimFold Horseshoe Shower Seat provides comfort, strength and assurance designed specifically for users who require support and extra assistance of bathing for areas of the body which are harder to reach.

The Horseshoe variation of the popular SlimFold Shower Seat addresses issues for personal intimate cleaning where standard seats restrict access.

## SlimFold Horseshoe Shower Seat dimensions



Sky Blue  
Code: SFSHS250WSB



Grey  
Code: SFSHS250WGY



White Stone  
Code: SFSHS250WWS



All SlimFold Horseshoe Shower Seat designs come as standard with White Stone wall fixed back

N.B. All SlimFold range colours are as accurate as the printing process will allow.

# Shower Seats

## Shower Seats, Chairs and Stools

All of our seats are robust, can be fitted at varying heights and have durable powder coated frames.

All have detachable plastic seat covers for easy cleaning. The seats carry a maximum weight limit of 30 stone (190 kg) unless stated otherwise. Some seats from the range require minimal assembly.

### Deluxe Padded Fold Down Shower Seat



Code: S1/P

Overall size (W x D)  
595mm x 545mm

Seat size (W x D x H)  
490mm x 380mm x 465mm - 615mm

Arm size (W)  
Inner: 490mm Outer: 595mm

Distance from wall in raised position:  
215mm

Maximum weight limit:  
30 stone (190kg)

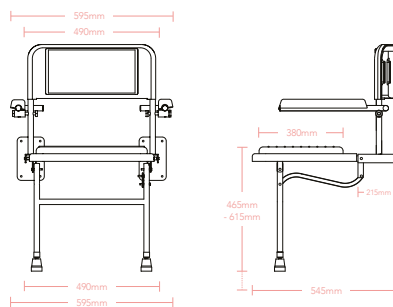

### Deluxe Fold Down Shower Seat



Code: S1/

Overall size (W x D)  
595mm x 545mm

Seat size (W x D x H)  
490mm x 380mm x 440mm - 590mm

Arm size (W)  
Inner: 490mm Outer: 595mm

Distance from wall in raised position:  
215mm

Maximum weight limit:  
30 stone (190kg)

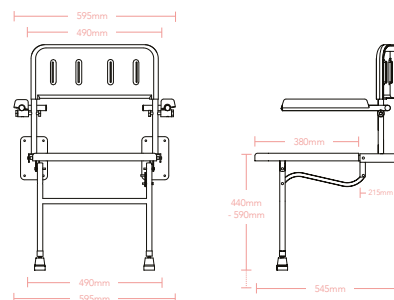

### Deluxe Horseshoe Padded Fold Down Shower Seat\*



Code: S1/HP

Overall size (W x D)  
610mm x 558mm

Seat size (W x D x H)  
437mm x 378mm x 510mm - 555mm

Arm size (W)  
Inner: 505mm Outer: 610mm

Distance from wall in raised position:  
175mm

Maximum weight limit:  
25 stone (160kg)

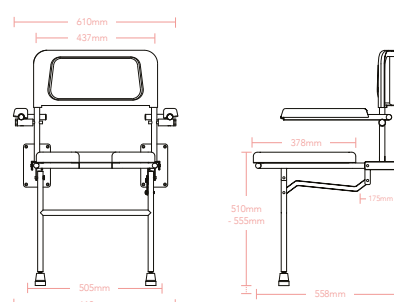

## Fold Down Shower Seat

Code: S2/



Overall size (W x D)  
490mm x 470mm

Seat size (W x D x H)  
460mm x 380mm x 460mm - 540mm

Distance from wall in raised position  
98mm

Maximum weight limit:  
30 stone (190kg)

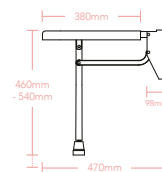
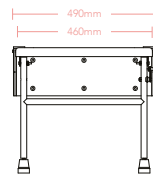

## Padded Fold Down Shower Seat

Code: S2/P



Overall size (W x D)  
490mm x 470mm

Seat size (W x D x H)  
460mm x 380mm x 485mm - 565mm

Distance from wall in raised position  
100mm

Maximum weight limit:  
30 stone (190kg)

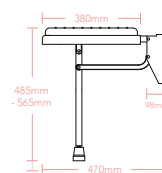
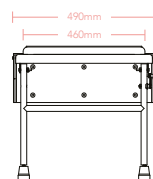

## Freestanding Shower Chair\*

Code: S5/



Overall size (W x D)  
475mm x 375mm

Seat size (W x D x H)  
430mm x 360mm x 450mm - 600mm

Maximum weight limit:  
30 stone (190kg)

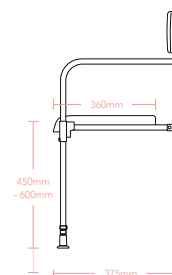
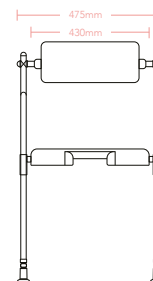

## Wide Padded Fold Down Shower Seat\*

Code: S9



Overall size (W x D)  
650mm x 510mm

Seat size (W x D x H)  
590mm x 420mm x 510mm - 580mm

Distance from wall in raised position  
100mm

Maximum weight limit:  
30 stone (190kg)

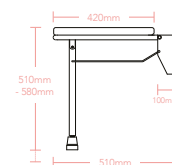
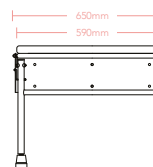

Lifetime Guarantee  
details on Page 94

\*Seats come with a 12 month guaranteee



For advice and support on any of our products, call our  
Technical team on 01460 256080 or visit [www.impeyshowers.com](http://www.impeyshowers.com)

# Grab Rails, Hand Rails and Accessories

## Maxi-Grip Plus

The strongest, easiest to grip and most versatile hand rail system on the market

A unique and innovative design that redefines what a grab rail should be.



Lifetime Guarantee details on Page 94



Made in the UK. See Pages 4 - 7

- Uses a square aluminium box section as reinforcement for maximum strength
- Supports up to 150kg (23 stone)
- Options for 90°, 60°, 45° or 30° angles
- Modular kits available allowing installers to deliver customised installations
- Available in 1.8m lengths that can be cut to size\*
- Can be used for internal or external corners
- Four point wall fixing and flared brackets reduce the stress points creating a secure fixture

\*Maximum length for installation is 900mm so must be trimmed down when bought in 1.8m lengths



For advice and support on any of our products, call our Technical team on 01460 256080 or visit [www.impeyshowers.com](http://www.impeyshowers.com)

Unique co-polymer extrusion gives the corner of the rails soft tactile qualities for increased grip and comfort in wet environments

Square design makes the rail easier to grip firmly and less likely to rotate

Developed with the help of the RNIB, colour contrast inserts to help the partially sighted locate the grab rail

Customisable kits



Aluminium core for maximum strength



View Maxi-Grip Plus video



# Grab Rails, Hand Rails and Accessories

## Maxi-Grip Plus

Maxi-Grip Plus Grab Rails are an innovation from Impey and have been developed with the help of the RNIB. Contains an aluminium core for maximum strength and can support up to 150kg (23 stone). Square design gives better grip and stops the Grab Rail from rotating.



Maxi-Grip Plus with 45° Angle



90° Angle can be used for internal and external corners



The 90° Adjustable Angle can be trimmed to 60°, 45° & 30° and the 45° can be trimmed to 30°

This is a patented design. Patent number: GB 2 481 259.

### Maxi-Grip Plus Hand Rail (White/Grey)

Size: 300mm Code: IGS30G  
Size: 450mm Code: IGS45G  
Size: 600mm Code: IGS60G  
Size: 900mm Code: IGS90G

### Maxi-Grip Plus Adjustable Angle

Angle: 45° White/Grey Code: IGA45G  
Angle: 90° White/Grey Code: IGA90G

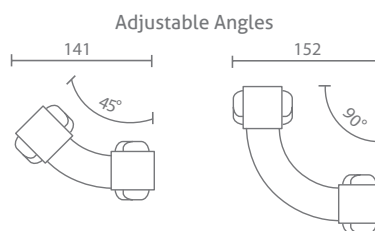

### Maxi-Grip Plus Modular Kits

Maxi-Grip Plus provides installers with the ability to provide customised installations with multi-packs of rails, brackets and angle brackets that can be trimmed to size and angled on-site.

1.8m Hand Rail: pack of 4 Code: MGRG184  
End Brackets: pack of 4 Code: MGEBG4  
Trimnable Angles: pack of 4 Code: MGCG4

Note: not to be cut down to lengths above 900mm.

# Maxi-Grip

The square profile improves slip resistance, whilst the unique co-polymer extrusion of Maxi-Grip Plus gives the corners of the rails a soft tactile quality for increased grip and comfort.

Maxi-Grip can support loads of up to 150kg (23 stone)\*. The range also includes options for 90°, 60°, 45° or 30° angles plus internal and external corners.

\*Refers to rails only, not fixings



Lifetime Guarantee  
details on Page 94



Made in the UK.  
See Pages 4 - 7



## Maxi-Grip Hand Rail (White)

Size: 300mm	Code: IGC30W
Size: 450mm	Code: IGC45W
Size: 600mm	Code: IGC60W
Size: 900mm	Code: IGC90W

## Maxi-Grip Adjustable Angle

Angle: 45° White	Code: IGA45W
Angle: 90° White	Code: IGA90W

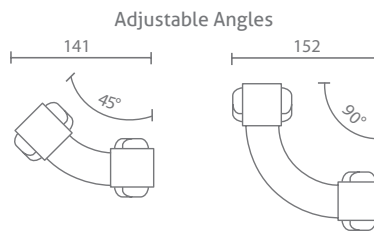
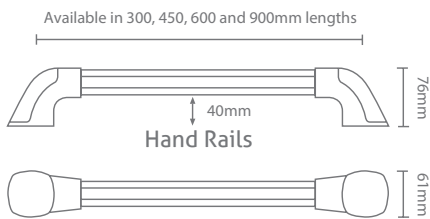

# Grab Rails, Hand Rails and Accessories

## Hand Rails

Engineered from industrial strength plastics, our satin finished fluted hand rails provide exceptionally good grip in wet environments.

Five screw points on each elbow ensure secure and easy wall fixing, with screw cover plates that snap on easily to provide a neat, easy to clean finish.



Lifetime Guarantee details on Page 94



### White Hand Rails

Size: 300mm Code: IG1F  
 Size: 450mm Code: IG4F  
 Size: 600mm Code: IG5F  
 Size: 900mm Code: IG6F

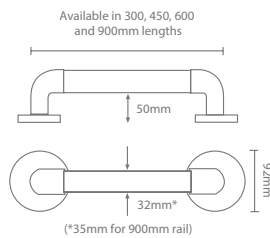

### Floor to Wall Hand Rail (white only)

Code: FWP

The Floor to Wall Hand Rail are manufactured from mild steel with a polyester finish and have an easy grip ribbed surface.



### Blue Hand Rails

Size: 300mm Code: IG1F/Blue  
 Size: 450mm Code: IG4F/Blue  
 Size: 600mm Code: IG5F/Blue

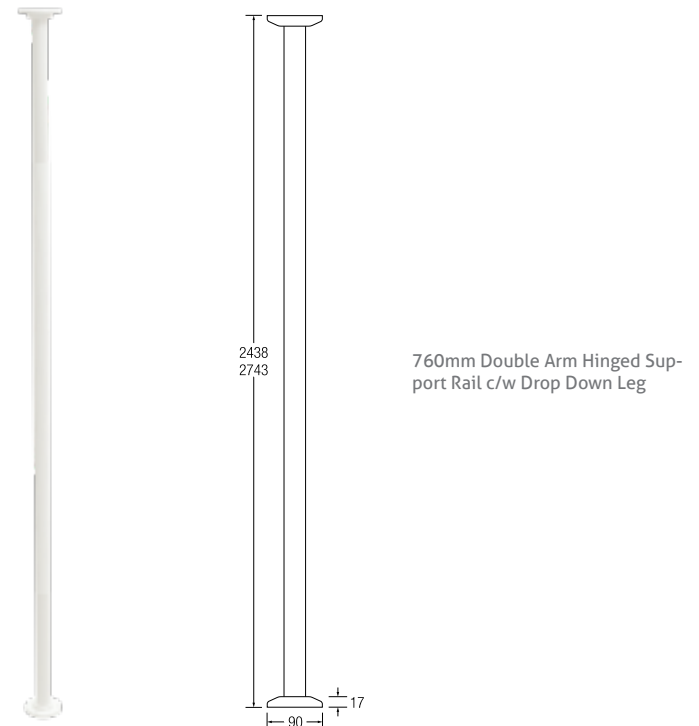
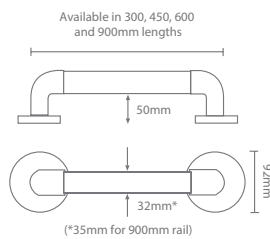

### Floor to Ceiling Pole (white only)

Code: FCP1

The Floor to Ceiling Pole are manufactured from mild steel with a polyester finish and have an easy grip ribbed surface.



### Angular Hand Rails (white only)

Size: 450mm Code: IG7  
 Size: 600mm Code: IG8

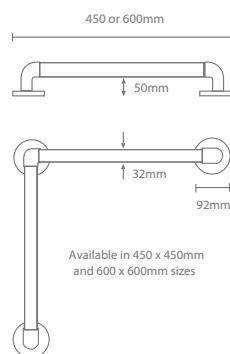

### Floor to Ceiling Pole Extension Kit

Code: FCP-EXT

# Fold Down Rails

We have a large range of Fold Down Rails to offer more assistance in the bathroom. Our robust powder coated rails are available in a variety of sizes and have additional optional extras including toilet roll holders and support legs.

The Fold Down Rails are perfect next to your WC, offering that little extra support when required.

Only available in white.

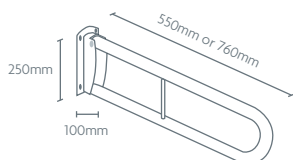

## Fold Down Rails

Size: 550mm Code: DR1  
 Size: 760mm Code: DR2  
 Size: 760mm with Toilet Roll Holder Code: DR7

Load Rating 170kg\* (26.5 Stone)

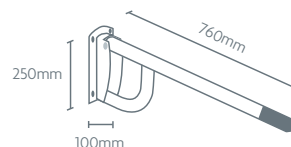

## Fold Down Single Rail

Size: 760mm Code: DR9

Load Rating 130kg\* (20.5 Stone)

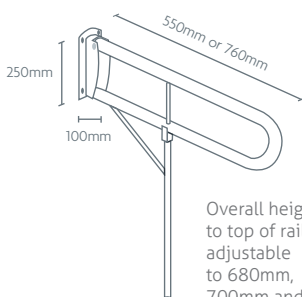

## Fold Down Rails (with supporting leg)

Size: 550mm Code: DR5  
 Size: 550mm Code: DR12  
 Size: 760mm Code: DR6  
 Size: 760mm with Toilet Roll Holder Code: DR8  
 Size: 760mm Code: DR11

Load Rating 200kg\* (31.5 Stone)

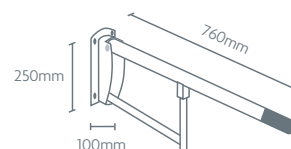

## Fold Down Single Rail (with supporting leg)

Size: 760mm Code: DR10

Load Rating 200kg\* (31.5 Stone)

DR5,6,8 – Not suitable for shower area  
 DR11,DR12 – Suitable for shower area (Stainless steel)

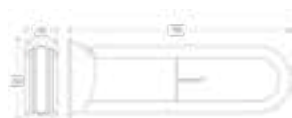

## Fold Down Rail with Toilet Roll Holder

Size: 760mm Code: DR7

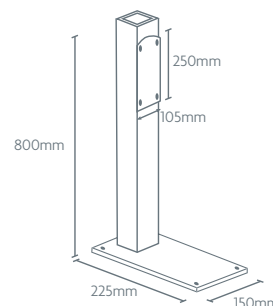

## Floor Mounted Post (to suit any hinged rail)

Code: DR3



\* Load ratings tested to BS8300 2009 in the horizontal position

Lifetime Guarantee details on Page 94

# Boston Comfort & Safety Range

## Creating the complete solution for a safe and stylish bathroom or wetroom

The Boston Comfort & Safety range enables you to complete your wetroom look with stylish living aid, including a variety of brushed and polished stainless steel accessories, providing a safe bathroom environment for those who do not wish to compromise on style.

■ Load bearing up to 150kg (23 stone)\* tested by TÜV

■ 25mm in diameter

■ CE Compliant

1



Shower Seat

Code:

Boston Comfort & Safety Shower Seat

299520346

\*up to 120kg (18 stone) for Shower Seat

TÜV UK  
CA CE



2



Right hand shown



Right hand shown

**Safety Grab Bar / Toilet Roll Holder**

**Code:**

Safety Grab Bar with Toilet Roll Holder 135° left stainless steel brushed 299120946

Safety Grab Bar with Toilet Roll Holder 135° left stainless steel polished 299120346

Safety Grab Bar with Toilet Roll Holder 135° right stainless steel brushed 299150946

Safety Grab Bar with Toilet Roll Holder 135° right stainless steel polished 299150346

**Safety Angled Grab Bar 135°**

**Code:**

Safety Bar 135° left stainless steel brushed 298720946

Safety Bar 135° left stainless steel polished 298720346

Safety Bar 135° right stainless steel brushed 298750946

Safety Bar 135° right stainless steel polished 298750346

3



**Safety Grab Bar - straight (3 sizes available)**

**Code:**

Safety Grab Bar 30cm stainless steel brushed 297720946

Safety Grab Bar 30cm stainless steel polished 297720346

Safety Grab Bar 45cm stainless steel brushed 297920946

Safety Grab Bar 45cm stainless steel polished 297920346

Safety Grab Bar 90cm stainless steel brushed 298120946

Safety Grab Bar 90cm stainless steel polished 298120346



**Folding Grab Bar**

**Code:**

Folding Grab Bar stainless steel brushed 299230946

Folding Grab Bar stainless steel polished 299230346

4

**Shower Rail with Safety Grip Handle**

**Code:**

Safety Shower Bar left stainless steel brushed 299720946

Safety Shower Bar left stainless steel polished 299720346

Safety Shower Bar right stainless steel brushed 299750946

Safety Shower Bar right stainless steel polished 299750346

Left hand shown

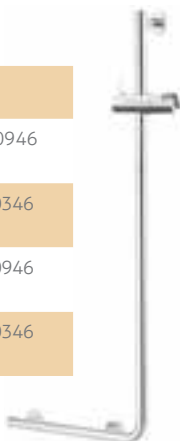

**Safety Bar 90°**

**Code:**

Safety Bar 90° left stainless steel brushed 298320946

Safety Bar 90° left stainless steel polished 298320346

Safety Bar 90° right stainless steel brushed 298350946

Safety Bar 90° right stainless steel polished 298350346

Right hand shown

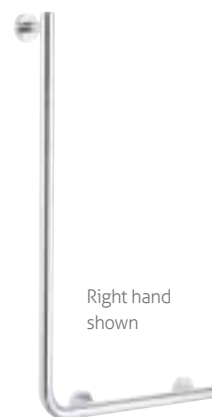

5

**Accessories**

**Code:**

Anti Slip Grip grey 297521046

Organiser grey 297621046



**Toilet Brush and Holder**

**Code:**

Toilet Brush and Holder stainless steel brushed 299920946

Toilet Brush and Holder stainless steel polished 299920346





# Mixer and Electric Showers

## A range to suit all applications

Impey offer a wide selection of showers from a variety of manufacturers, in order to provide you with the best choice for your requirements. The entire range features thermostatic controls, for added safety, plus you have the option of the finest quality mixer shower, or easy to install electric showers.



### Mixer Showers

Page 76



### Electric Showers

Pages 77 - 79



For advice and support on any of our products, call our Technical team on 01460 256080 or visit [www.impeyshowers.com](http://www.impeyshowers.com)

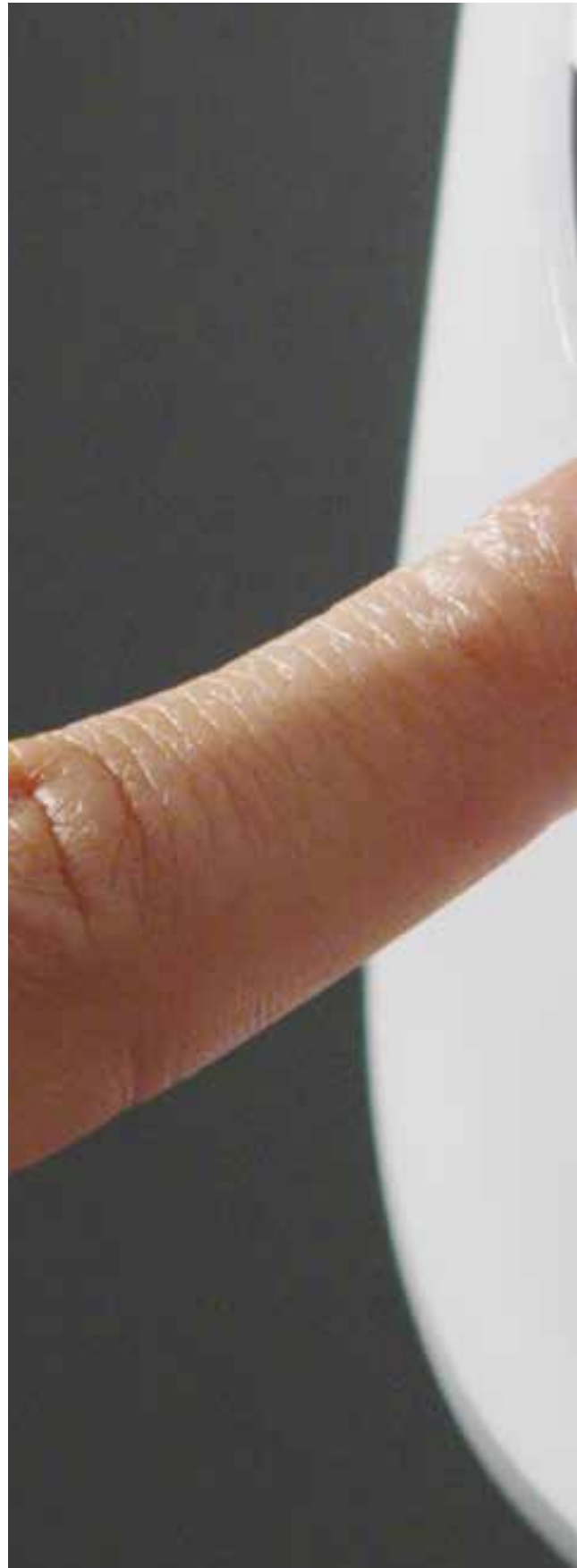

Start | Stop



Status



# Mixer Showers

Features	Mira Select Flex Thermo Mixer Code: MIRASELFLEX	Impey TMV2 Code: TMV2KIT	Impey TMV3 Code: TMV3KIT
Tank/Mains Fed	Tank or Mains	Tank or Mains	Tank or Mains
Pump compatibility Switch Connect	Yes	Yes	Yes
Shower Head	Single spray rub clean nozzles Limescale resistant	3 spray modes Spray, Rinse, Pulse	3 spray modes Spray, Rinse, Pulse
Length of Hose	2m (Anti-Twist)	2m	2m
TMV2/TMV3	TMV2 and TMV3	TMV2	TMV3
WRAS	Yes	Yes	Yes
Warranty	5 years	5 years	5 years



#### Technical Specification

- Separate flow and temperature controls with extended levers
- Thermostatic temperature stability for safe showering of 1°C
- Adjustable maximum temperature setting for added safety
- Fail safe on hot and cold supplies
- 'Cool Touch' shower valve for added safety
- 'Everclear' limescale resistant showerhead with single spray pattern
- Extended riser rail (1m) and 2m hose
- Wall or corner mounting options
- Variable pipe inlet centres (139-153mm)
- Inlet connection: 15mm compression
- Outlet connection: ½" BSP flat face
- Operating pressure range of 0.1 to 5 bar
- Maximum inlet temperature: 65°C
- Minimum temperature differential to achieve hot or cold failsafe: 12°C
- Suitable for unvented, pressurised, combi-boiler, gravity fed and mains pressure systems
- Guaranteed for 5 years



#### Technical Specification

- Suitable for use with unvented supplies, combi boilers, gravity and mains pressure systems
- Thermal cartridge technology
- Temperature stability of ± 2°C
- Fail safe protection on both the hot and cold supplies
- Operating pressure range of 0.2 to 5 bar
- TMV2 / WRAS approved
- 5 year warranty



#### Technical Specification

- Suitable for use with unvented supplies, combi boilers, gravity and mains pressure systems
- Thermal cartridge technology
- Temperature stability of ± 2°C
- Fail safe protection on both the hot and cold supplies
- Operating pressure range of 0.2 to 5 bar
- Safe touch body
- TMV3 / WRAS approved - complies with NHS D08 and BS7942
- 5 year warranty

TMV2KIT & TMV3KIT must be bought alongside the Fast fix Bracket kit. Code: 20010CP

# Electric Showers

Features	Mira Advance Flex 8.7 Code: MIRAADVLEX87	Mira Advance Flex 9.8 Code: MIRAADVLEX98	Mira Advance Flex Extra 8.7 Code: MIRAADVLEXEXT87	Mira Advance Flex Low Pressure Code: MIRAFLEX/LP90
k.W	8.7	9.8	8.7	9.0
Tank/Mains Fed	Cold Mains	Cold Mains	Cold Mains	Tank Fed
Pump compatability:				
- Bluetooth	No	No	Yes	No
- Switch Connect	Yes	Yes	Yes	Yes
- Wired Pump Connection	No	No	Yes	No
Shower Head	3 spray modes, removable easy clean plate	3 spray modes, removable easy clean plate	3 spray modes, removable easy clean plate	4 spray modes, rub clean nozzles
Length of Hose	2m (Anti-Twist)	2m (Anti-Twist)	2m (Anti-Twist)	2m (Anti-Twist)
BEAB	Yes	Yes	Yes	Yes
RNIB	Yes	Yes	Yes	Yes
WRAS	Yes	Yes	Yes	Yes
Warranty	2 years	2 years	2 years	2 years



## Technical Specification

- Pumped electric shower - the ideal choice for low pressure sites
- Separate flow and temperature controls with push button start/ stop and audible beeps
- Thermostatic temperature control for added safety
- Four spray pattern showerhead with rub clean rubber nozzles for easy cleaning
- Extended riser rail (1m) with easy one-handed adjustment of the height of the shower head, plus additional parking socket
- Best in class limescale resistance
- Guaranteed for 2 years, with optional 3 year extended warranty

## Technical Specification

- Easily accessible controls with high contrast on critical touch points
- Four different maximum temperature settings
- Anti-glare matte finish to panels
- Phased shutdown flushes hot water from the tank to make it safe for next user
- Suitable to be paired with the Whale Switch Connect Pump

## Technical Specification

- Specifically designed to be compatible with the Whale Instant Match Bluetooth Pump using Easy Pair technology. A digital signal from the shower automatically adjusts the pump speed in relation to the shower flow rate.
- Easily accessible controlled with high contrast on critical touch points
- Four different maximum temperature settings
- Anti-glare matte finish to panels
- Phased shutdown flushes hot water from the tank to make it safe for next user

## Technical Specification

- Pumped electric shower - the ideal choice for low pressure sites
- Separate flow and temperature controls with push button start/ stop and audible beeps
- Thermostatic temperature control for added safety
- Four spray pattern showerhead with rub clean rubber nozzles for easy cleaning
- Extended riser rail (1m) with easy one-handed adjustment of the height of the shower head, plus additional parking socket
- Best in class limescale resistance
- Guaranteed for 2 years, with optional 3 year extended warranty

# Electric Showers

Features	Triton Omnicare Design 8.5 Code: TEOMNDD81	Triton Omnicare Design 9.5 Code: TEOMNDD91	Redring Selectronic Premier Plus 8.5 Code: RSELP85P
k.W	8.5	9.5	8.5
Tank/Mains Fed	Cold mains	Cold mains	Cold mains
Pump compatability:			
- Bluetooth	No	No	No
- Switch Connect	Yes	Yes	Yes
- Wired Pump Connection	Yes	Yes	No
Shower Head	5 spray modes, rub clean nozzles	5 spray modes, rub clean nozzles	6 spray modes, rub clean handset
Length of Hose	2m (Anti-Twist)	2m (Anti-Twist)	2m
BEAB	Yes	Yes	Yes
RNIB	Yes	Yes	Yes
WRAS	No	No	Yes
Warranty	2 years	2 years	3 years



NEW



The entire range features thermostatic controls, for added safety

## Technical Specification

- Thermostatic temperature reassurance - Regulates water temperature within +/-1°C
- Audible feedback and tactile temperature dial with soft grey tones offers assistance to visually impaired users
- Easy operation – A soft press start/stop power button and looped lever handle offer low resistance control of the shower
- Safe-set™ - Allows the maximum temperature to be set whilst allowing full rotation of temperature dial
- 2m Anti-Twist hose
- Ease of replacement – Includes multiple cable & water entry points, generous footprint & a fixing hole kit.
- Connects to both analogue and digital waste pumps

## Technical Specification

- Thermostatic temperature reassurance - Regulates water temperature within +/-1°C
- Audible feedback and tactile temperature dial with soft grey tones offers assistance to visually impaired users
- Easy operation – A soft press start/stop power button and looped lever handle offer low resistance control of the shower
- Safe-set™ - Allows the maximum temperature to be set whilst allowing full rotation of temperature dial
- 2m Anti-Twist hose
- Ease of replacement – Includes multiple cable & water entry points, generous footprint & a fixing hole kit.
- Connects to both analogue and digital waste pumps

## Technical Specification

- Separate temperature controls with large push button start/stop and audible bleeps
- Clear print control identification for ease of visibility and legibility
- Large LED temperature readout display
- Thermostatic temperature control for added safety
- Adjustable maximum temperature setting for added safety
- Eco Water-Save feature that automatically calculates and adjusts the optimum flow rate.
- Phased shutdown reduces limescale and ensures a cool start for added safety for the next user.
- Automatic shutdown after 30 minutes of inactivity
- 6 spray pattern shower head with rub clean nozzles for easy cleaning
- Extended riser rail (1m) with 2m hose
- Guaranteed for 3 years, with optional 2 year extended warranty

Features	<b>Redring Selectronic Premier Plus 9.5</b> Code: RSELP95P
k.W	9.5
Tank/Mains Fed	Cold mains
Pump compatability:	
- Bluetooth	No
- Switch Connect	Yes
- Wired Pump Connection	No
Shower Head	6 spray modes, rub clean handset
Length of Hose	2m
BEAB	Yes
RNIB	Yes
WRAS	Yes
Warranty	3 years

**NEW**



#### Technical Specification

- Separate temperature controls with large push button start/stop and audible bleeps
- Clear print control identification for ease of visibility and legibility
- Large LED temperature readout display
- Thermostatic temperature control for added safety
- Adjustable maximum temperature setting for added safety
- Eco Water-Save feature that automatically calculates and adjusts the optimum flow rate.
- Phased shutdown reduces limescale and ensures a cool start for added safety for the next user.
- Automatic shutdown after 30 minutes of inactivity
- 6 spray pattern shower head with rub clean nozzles for easy cleaning
- Extended riser rail (1m) with 2m hose
- Guaranteed for 3 years, with optional 2 year extended warranty



# Showers & Waste Pump Kits

## Wireless controlled pumped drainage options

For drainage that requires a waste pump we offer showers which provide a more economical and easy to install solution.

These showers can be directly connected to the waste water pump rather than fitting a separate flow switch or sensor, together with the additional wiring connections.

The latest innovation from Mira and Whale provides wireless control pumped drainage, reducing installation time and the need for additional wiring between the pump and the shower.

### Whale Instant Match Bluetooth Pump



- 1 Transformer** - Initiates start-up of the pump. Regulates the flow rate and controls pump shut down.
- 2 A flow sensor** in the shower communicates to the transformer via Bluetooth wireless technology.
- 3 Instant Match with Bluetooth wireless technology pump** - Quiet running waste pump. Designed to pump up to 8 litres per minute. The pump has integral non-return valves and requires no filter.
- 4 Gullies** - Matching the pump speed to the shower flow rate ensures that gully suction noise is minimised.

Maximum distance from the gully to the pump is 3 metres.



Watch how Whale Instant Match Bluetooth Pump Kit and Mira Advance Flex Extra shower work together

Scan the QR code to watch our UK Manufacturing video

Integral sensors ensure the pump flow rate matches the shower flow rate to provide the most efficient drainage. This also reduces noise output considerably, whilst also reducing wear on the pump.

	Mira & Whale Advance Flex Extra 8.7kW & Instant Match Bluetooth Pump Code: MIRIM/BT	Impey & Whale TMV2 & Instant Match Premium Code: TMV2/IMP
Mixer or Electric shower	Electric	Mixer
Pump capacity	Up to 8 litres/minute	Up to 12 litres/minute
Bluetooth technology	Yes	No
BEAB	Yes	No
RNIB	Yes	No
WRAS	Yes	Yes
TMV2/TMV3	No	TMV2
Warrant /	2 years on shower / 5 years on pump	5 year warranty



#### Technical Specification

- Featuring Bluetooth 'Easy Pair' technology between the shower and pump
- Specially designed to be partnered with the Whale Instant Match Premium Pump
- Easily accessible controls with high contrast on critical touch points
- Four different maximum temperature settings
- Anti-glare matte finish to panels
- Phased shutdown flushes hot water from the tank to make it safe for next user
- Wireless flood prevention two way communications between the shower and the pump reduces risk of flooding if the power to the pump is turned off.



TMV2/IMP must be bought alongside the Fast fix Bracket kit. Code: 20010CP



#### Technical Specification

- Temperature stability of  $\pm 2^{\circ}\text{C}$
- Fail safe protection on both the hot and cold supplies
- Operating pressure range of 0.2-0.5 bar
- TMV2/WRAS approved
- Quiet operation to pump with built in anti-vibration mounts.
- Acoustically tested
- Latest switch mode technology in the transformer
- New self cleaning flow sensor technology
- No need for filters
- Plug and play installation

# Showers & Waste Pump Kits

Shower Waste Pump Kits can be fitted when gravity drainage is not an option. The pump is activated by a flow switch or flow sensor installed in the water supply to the shower.

When the shower is turned on water passes through the flow switch or flow sensor, activating the pump. Alternatively we offer one pump that is controlled directly by a connection to an electric shower, without the need for a flow switch.

All our pumped kits are suitable for wetroom floors or shower trays and include all the fittings needed for a single feed electric shower installation, but please note that for mixer showers you will need a Mixer Shower Conversion Kit and for wetroom floors you will require a TAD13 shallow waste gully (see page 39).



## Whale Switch Connect Kit

Code: SWP

This is the original waste pump kit and has been successfully installed in over 150,000 homes across the UK.

### Technical Specification

- Maximum drainage for electric showers 8l/min
- Maximum drainage for mixer showers 12ltrs per minute (additional mixer valve conversion kit required) SWP/MX
- Self priming pump with protective cover
- Low voltage transformer conforms to EN60742
- 12 adjustable settings for electric & mixer showers
- Active link diagnostics
- De-puddling cycle: pump turns on for a brief period, 15 min after shower is turned off
- IP45 Rated



## Whale Direct Connect Kit

Code: SWP/WM

Based on the Switch Connect original waste pump kit, the Direct Connect kit is designed for direct connection to electric showers without the need for a flow switch.

### Technical Specification

- Designed for electric showers only. Direct connection compatibility with electric shower is required
- Maximum drainage for electric showers 8l/min
- Self priming pump with protective cover
- Low voltage transformer conforms to EN60742
- 12 adjustable settings for electric & mixer showers
- Active link diagnostics
- De-puddling cycle: pump turns on for a brief period, 15 min after shower is turned off
- IP45 Rated

	Whale Switch Connect Pump Kit	Whale Direct Connect Pump Kit	Whale Instant Match Bluetooth Pump Kit	Whale Instant Match Premium Pump Kit
Code	SWP	SWP/WM	SWP/IMBT	SWP/IMP
Warranty	3 years (extended to 5 years with registration)	3 years (extended to 5 years with registration)	3 years (extended to 5 years with registration)	3 years (extended to 5 years with registration)
Bluetooth Compatible	No	No	Yes with Mira Advance Flex Extra (MIRAADVFLXEXT87)	No
Noise reduction / Anti-vibration	No	No	Available as an upgrade	Yes
Maximum drainage capacity (litres per min)	Max drainage for mixer = 12l per min Max drainage for electric = 8l per min	Max drainage for electric = 8l per min	Max drainage for electric = 8l per minute	Max drainage for mixer = 12l per min Max drainage for electric = 8l per min
External switch to run the pump	No	No	Yes	Yes
Auto shower-stop (Mira showers only)	No	No	Yes (bluetooth operated)	Yes
Shower compatibility	Mixer showers and electric showers	Electric showers	Electric showers	Mixer showers and electric showers



## Whale Instant Match Bluetooth Pump Kit

Code: SWP/IMBT

Designed to be specifically compatible with the Mira Advance Flex Extra using Easy Pair bluetooth technology. A digital signal from the shower automatically adjusts the pump speed in relation to the shower flow rate.

### Technical Specification

- Maximum drainage 8l/min
- Self priming pump with protective cover
- Low voltage transformer conforms to EN60742
- Active Link Diagnostics
- Anti-flood feature with Mira Advance Flex Extra\* - turns shower off if no power on pump
- IP45 rated

\*Purchase the Mira Advance Flex Extra and Bluetooth pump together using code MIRIM/BT



## Whale Instant Match Premium Pump Kit

Code: SWP/IMP

Quiet operation, because the speed is regulated depending on the flow rate of water from the shower. This reduces noise output considerably, whilst also reducing wear on the pump.

### Technical Specification

- Maximum drainage 12l/min
- Automatically adjusts to changes in shower flow rate
- Compensates for changes in voltage from main electric supply
- Self priming pump with protective cover
- Low voltage transformer conforms to EN60742
- IP45 rated



For advice and support on any of our products, call our Technical team on 01460 256080



**5 YEAR WARRANTY**  
ON ALL WHALE KITS



### Whale Pump Service Kit

Code: SWP/DT

Suitable for:

- Whale Switch Connect Kit Code: SWP
- Whale Direct Connect Kit Code: SWP/WM



Also includes two  
22mm push-fit fixtures

### Whale Mixer Shower Conversion Kit for SWP Pump

Code: SWP/MX

When fitting the pump in conjunction with a mixer shower this mixer shower conversion kit is required.

Suitable for:

- Whale Switch Connect Kit Code: SWP



### Tricuspid/non-return valves - pack of 10

Code: SWP/TV



### Whale 15mm Flow Switch Kit

Code: SWPFS

Suitable for:

- Whale Switch Connect Kit Code: SWP



### Whale Spare Pump Head

Code: SWP/PH

Suitable for:

- All Impey Whale shower waste pumps



### Whale Spare Pump Only

Code: SWP/PO

Suitable for:

- Replacement of all Impey Whale shower waste pumps



### Whale Pump Transformer for Switch Connect

Code: SWP/TMK2

Suitable for:

- Whale Switch Connect Kit Code: SWP



### Whale Pump Transformer for Instant Match Kit

Code: SWP/IMBT

Suitable for use with SWP/IMBT

- Whale Instant Match Premium Pump Kit Code: SWP/IMP

# Toilets and Bathroom Accessories

## Palma Vita Automatic WC

The Closomat Palma Vita Automatic WC shower toilet provides flushing, warm water washing, and warm air drying from one simple operation. Simple to operate, it is purpose-designed to combine a conventional WC with an integrated washing and drying cycle. It is the only toilet of its kind, specifically developed for elderly and disabled people, designed to properly support the user and position them correctly for effective washing and drying. It is user-friendly for people who have restricted use of their hands. By reducing hand contact, it also provides improved hygiene for all users. The Touch Sensitive Switch can be placed on the floor and operated by a foot, eliminating hand contact, if required.

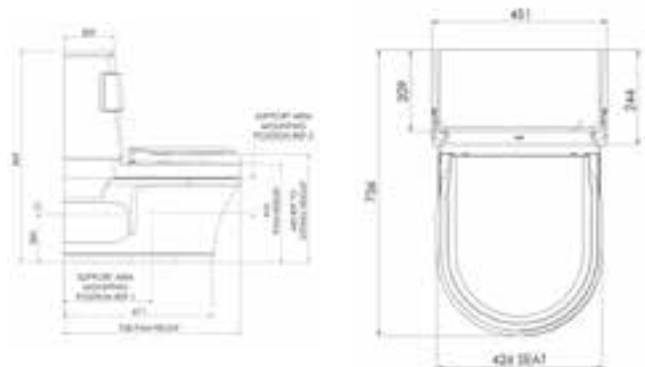

### Simultaneous flushing and washing

This unique feature improves personal hygiene - cleaning with water, not paper. Can be used at all times as a conventional WC.

Combines functions of a WC and bidet with the addition of drying air.

The Palma Vita's unique one-touch system allows the user to benefit from the toilet's automatic functions by just pressing and releasing the flush. Wash time adjustable to client needs.

Safe working load: 190kg (30 stone)  
Maximum user weight: 362kg (57 stone) when fitted with Big John Seat.

Made in a dedicated plant within the UK.



### Closomat Optional Extras

There is a range of accessories available for the Palma Vita Automatic WC including seats, integrated fold down support arms, lateral body supports, plinths to raise the height and a touch pad for those who cannot use the flush button.



Soft Seat  
Code: SOFTSEAT



Fold Down Support Arms  
Code: FOLDDOWNARMS



Lateral Body Supports  
Code: LATERALBODYSUPPORTS



Big John Seat  
Code: BIGJOHNSEAT



Palma Vita Toilet Plinth  
Code: SHAPEDPLINTH



Touch Sensitive Hand/Foot Switch  
Code: HAND/FOOTSWITCH

# Bathroom Accessories

## Toilet Plinths

For wheelchair users and people with limited mobility conventional toilets can be too low and very difficult to use.

The Impey toilet plinths have been designed to raise the existing toilet to account for these needs. Their non-intrusive design allows for greater flexibility in the bathroom and removes the need to purchase a new toilet while remaining discreet.

**25mm Toilet Plinth Code: IP25**  
Raises the height of the toilet by 25mm

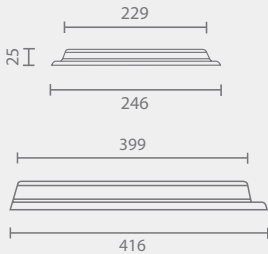

**50mm Toilet Plinth Code: IP50**  
Raises the height of the toilet by 50mm

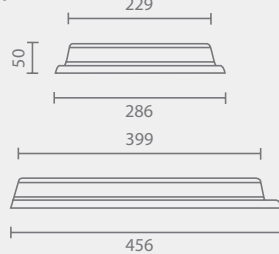

**75mm Toilet Plinth Code: IP75**  
Raises the height of the toilet by 75mm

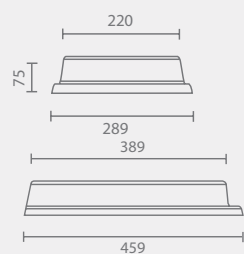

**100mm Toilet Plinth Code: IP100**  
Raises the height of the toilet by 100mm

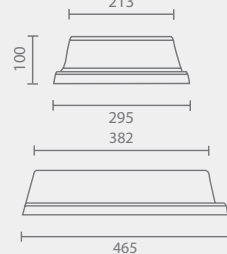

Back to Wall Plinths are available. **Codes: IPBW25, IPBW50, IPBW75, IPBW100**

## Impey Plastic Access Panels

The Plastic Access Panel is designed to fit into any wall and ceiling where access is required to stopcocks, pipes etc. Or simply use to fill unsightly holes, saving the need for expensive repairs. The high impact styrene plastic with UV stabilisers will not fade or corrode.

- Easy installation
- 3mm thick High Impact Styrene Plastic with UV stabilisers
- White textured exposed surfaces, which allow for painting
- Available in 4 sizes:
 

<b>152 x 228</b>	Code: AP1523
<b>203 x 203</b>	Code: AP2020
<b>300 x 300</b>	Code: AP3030
<b>355 x 355</b>	Code: AP3535

## Apres Body Dryer

Code: BODYDRYER

The Apres Body Dryer is a complete all-over body dryer.

Tested to rigorous safety standards, it fits neatly into most bathing and shower areas and helps make towels a thing of the past.

### Technical Specification

- Height: 2075mm
- Voltage: 220/240V
- Normal output: 2.9kW
- Average air outlet temperature: 20°C
- 2 speed on/off air switch
- ABS plastic construction
- Tested to EN60 335-2-23 1990
- Sound level: 70dB
- 3 year warranty.



## Extractor fans by Xpelair

- Flow straighteners guide air through ducting which reduces turbulence, smoothing and making the air flow laminar
- A cone reduces turbulence in front of the fan and air is directed straight into the impeller
- Ball-bearing motors suppress noise from the motor.



**NEW** Simply Silent Intermittent Extractor Fan with Timer Square/Round  
Code: C4HTSR (Note: both square and round cap are included)

Simply Silent Fan Kit Low Voltage  
Code: LV100T

Simply Silent DC Low Voltage Constant Volume Fan with external transformer  
Round or Square

Round Code: LVCV4R

Square Code: LVCV4S



# Toilets and Bathroom Accessories

## Sankit Range

The contract, care and commercial sanitary-ware range looks beautiful and delivers improved practicalities.

With eighteen options available, this range offers an ideal choice to suit the preferences of the end-user as well as budget.

The toilets are available in 390mm or 460mm high, standard soft close seat and cover as well as choice of a level flush or push button.

			No Basin required
 <ul style="list-style-type: none"> <li>• Close Coupled Comfort Height Pan</li> <li>• 460mm High</li> <li>• Soft Close Seat and Cover</li> <li>• Lever Flush Cistern (including fittings)</li> </ul>	IMPSAN1	IMPSAN2	IMPSAN13
 <ul style="list-style-type: none"> <li>• Close Coupled Comfort Height Pan</li> <li>• 460mm High</li> <li>• Soft Close Seat and Cover</li> <li>• Push Button Flush Cistern (including fittings)</li> </ul>	IMPSAN3	IMPSAN4	IMPSAN14
 <ul style="list-style-type: none"> <li>• Low Level Pan</li> <li>• 460mm High</li> <li>• Soft Close Seat and Cover</li> <li>• Low Level Lever Flush Cistern (including fittings)</li> </ul>	IMPSAN9	IMPSAN10	IMPSAN17
 <ul style="list-style-type: none"> <li>• Low Level Pan</li> <li>• 390mm High</li> <li>• Soft Close Seat and Cover</li> <li>• Low Level Lever Flush Cistern (including fittings)</li> </ul>	IMPSAN11	IMPSAN12	IMPSAN18



For advice and support on any of our products, call our Technical team on 01460 256080 or visit [www.impeyshowers.com](http://www.impeyshowers.com)

## Toilets

Our range of products are comfortable, practical and better designed to suit the needs of users.

### Close Coupled Pan

The attractive contemporary style of the suite takes comfort products to a new level. The suite features a close coupled box rim P trap WC with a choice of either raised height single push button or conventional lever flush cistern. Both options give an economical 6 litre flush. All seats and covers come with soft close as standard.

### Low Level Pan

A traditional low level style elevated pan with a choice of either raised height single push button or conventional lever flush BIBO cistern. Both options give an economical 6 litre flush. All seats and covers come with soft close as standard.

## Basins

Smart and attractively designed this compact basin will suit all applications. Available with either 1 or 2 tap hole options with matching semi-pedestal.

### 500mm 1th Basin with Mono Basin Mixer Tap

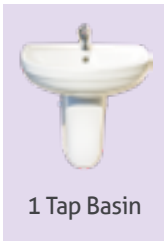

1 Tap Basin

Click Clack Waste, Semi-ped, Basin brackets, Bottle trap, Flexible Tails\*, Semi-pedestal fixing brackets

\*Copper Tails are available at an additional cost

### 500mm 2th Basin with 3" Basin Lever Taps



2 Tap Basin

Click Clack Waste, Semi-ped, Basin brackets, Bottle trap, Semi-pedestal fixing brackets



### Thermostatic Mixing Valve (TMV2) 15mm



TMV2 is designed to eliminate the risk of scalding and are suitable for use in a wide range of public, health care, social, commercial and domestic applications.



TMV2 15mm  
Code: IMPSANTMV

## Doc M Close Coupled Packs

A stylish Doc M Close Coupled toilet suite which would not look out of place in any bathroom or toilet setting. The Doc M suite has a hygienic high gloss white glaze finish and superior flushing performance and is available with spatula lever handle.

For ease of installation the pack is universal and the basin can be installed on either side of the WC. The cistern spatula lever can also be fitted on the left or right hand side to suit the required orientation and comes with a blank for the unused hole. All necessary fittings such as the basin sequential mixer tap, basin waste, bottle trap and cistern spatula handle together with the hinged support rail and grab rails in white or blue are included.



### Doc M Pack

Close Coupled White  
Code: IMPSAN19



### Doc M Pack

Close Coupled Blue  
Code: IMPSAN20

Proudly working in partnership with



### Lifetime Guarantee

Impey guarantees its range of branded showering products against faulty materials or manufacture for a lifetime, provided that they have been installed and maintained in accordance with the manufacturer's instructions.

The guarantee extends to non-electrical products in general use and excludes normal wear and tear. For products such as taps, shower valves, bathroom accessories, waterproofing and electrical products, the standard manufacturer's guarantee will apply. Where products included in the Lifetime Guarantee are used for commercial use, such as hospitals, nursing homes or hotels, a 5 year guarantee will be applicable.

Parts that are defined as wearing parts, such as seals, seat pads etc, are subject to a 5 year guarantee.

If in our opinion the product has been modified, neglected, misused or is the subject of accidental damage the guarantee will not be applicable.

Impey has a policy of continuous improvement and therefore reserves the right to revise or amend the specification of any product without notice.

In situations where a product has failed, subject to the terms of the guarantee, and a direct replacement is no longer available, Impey will replace it with the nearest equivalent product.

The liability of Impey does not extend to consequential loss or damage arising from the defective product and is limited to the price of the original goods supplied by Impey.

The guarantee is in addition to your statutory rights.

### Sankit Range Guarantee (Pages 86 - 87)



Our 10 year warranty applies to all ceramic sanitary products, excluding normal wear and tear in general domestic applications.



Our 5 year warranty applies to 3" Lever Basin excluding normal wear and tear in general domestic applications.



Our 2 year warranty applies to the Push Button Flush and TMV2 15mm, excluding normal wear and tear in general domestic applications.



Our 12 month warranty applies to all internal components, excluding normal wear and tear in general domestic applications.

Please note, our warranty on all products does not include installation or third party damage, or any form of impact damage and must be in accordance to relevant local and national regulations.

Full terms and conditions available on our website [www.impeyshowers.com](http://www.impeyshowers.com)

Level-Dec EasyFit, Maxi-Grip, Radiate, Mendip and Mantis are all trademarks of Impey

### Impey

Conquest Business Park  
Cad Road  
Ilton  
Somerset  
TA19 9EA

Part of Coram Group



01460 256080  
www.impeyshowers.com  
salesorders@impeyshowers.com

---

**Impey**  
Conquest Business Park, Cad Road,  
Ilton, Somerset, TA19 9EA

---

@impeyshowers



**Intertek**



**Intertek**

Printed with biodegradable laminate:

- ✓ protecting the environment from single use plastics
- ✓ reducing negative impact on the environment.

Whilst every care has been taken to ensure that the information included in this document was accurate at the time of printing, we reserve the right to change product specifications at any time without prior notice.

The photographs reproduced in this document publication are within the constraints of the printing process and are not to be used for matching purposes. All photographs are used for approximate representation only and may not show the actual products on offer. Errors and Omissions Excepted.

Full terms and conditions available at [www.impeyshowers.com](http://www.impeyshowers.com)

03/2023